

1/4/73
VT 12AT7 AMPORTEX Only

**GT550
MANUAL**

INSTRUCTION MANUAL



GALAXY ELECTRONICS

"Pioneers in American/Canadian Equipment Design"
10 South 34th Street • Council Bluffs, Iowa 51501

K4XL's **BAMA**

This manual is provided **FREE OF CHARGE** from the "BoatAnchor Manual Archive" as a service to the Boatanchor community.

It was uploaded by someone who wanted to help you repair and maintain your equipment.

If you paid anyone other than BAMA for this manual, you paid someone who is making a profit from the free labor of others without asking their permission.

You may pass on copies of this manual to anyone who needs it. But do it without charge.

Thousands of files are available without charge from BAMA. Visit us at <http://bama.sbc.edu>



The new Galaxy GT550 offers you higher power, improved ALC with linear amplifier input provisions plus the smoothest tuning ever offered in an amateur transceiver. The GT550 maintains the same high standard of performance and rugged reliability that has become a trademark at Galaxy. Backed by a full year warranty and the best service policy ever, we know that the Galaxy GT550 will establish a new standard of value for the industry.

INDEX

SECTION 1 - UNPACKING ----- 1

- 1.1 Removing from Carton
- 1.2 Warranty Registration
- 1.3 Shipping Carton
- 1.4 Re-Assembly

SECTION 2 - INSTALLATION ----- 2

- 2.1 General
- 2.2 Antenna
- 2.3 Speaker
- 2.4 Microphone
- 2.5 Power
- 2.6 Location
- 2.7 Control Functions
- 2.8 Rear Panel Connections
- 2.9 Location of Internal Adjustments

SECTION 3 - OPERATION ----- 17

- 3.1 General
- 3.2 Ground Connection
- 3.3 Bias Setting
- 3.4 "S" Meter Zero Set
- 3.5 Accessory Installation
- 3.6 Receiver Operation
- 3.7 Transmitter Operation
- 3.8 Mobile Tune-Up

SECTION 4 - THEORY OF OPERATION ----- 27

- 4.1 General Circuit Analysis (Transmitter)
- 4.2 General Circuit Analysis (Receiver)
- 4.3 VOX Circuitry
- 4.4 VFO Tuning Dial

SECTION 5 - TEST & ALIGNMENT ----- 32

- 5.1 General
- 5.2 Test Equipment Required
- 5.3 Alignment
- 5.4 Troubleshooting

SECTION 6 - PARTS LIST -----	46
SECTION 7 - SERVICE INFORMATION -----	56
SECTION 8 - WARRANTY -----	58

LIST OF ILLUSTRATIONS

FIGURE NUMBER	DESCRIPTION	PAGE NUMBER
1	Microphone Connection	3
2	Power Plug Connection	4
3	Fixed Station Cable Connections	5
4	Linear Cable Connections	6
5	Mobile Cable Connections	7
6	Front-View of the GT550	9
7	Rear-View of the GT550	13
8	Bias Set Point	18
9	Calibrator Installation	19
10	VOX Installation	20
11	GT550 Block Diagram	30
12	VFO Tuning Dial Illustration	31
13	Converter Alignment Identification	34
14	Top View of GT550	35
15	GT550 Resistance Readings	43
16	GT550 Tube Voltage Chart	44
17	GT550 Transistor Voltage Chart	45
18	Galaxy GT550 Schematic	Inside back cover

SECTION 2

INSTALLATION

2.2 General:

Do not attempt to operate your GT550 or to make any connections until you have read this entire section carefully and understand its content.

2.2 Antenna:

The GT550 will work with any of the common antenna systems designed for use on the high frequency amateur bands, provided the impedance is not beyond the capability of the pi-network. An antenna that has a resistive impedance between 40 to 100 ohms will take power from the GT550. SWR should be kept to a minimum, preferably less than 2:1. The antenna connection provided on the rear panel of the GT550 is an SO-239. To connect your antenna you will need to provide a PL-259 connector.

Remember that the most powerful transmitter is useless without a good antenna and feedline. These two items are often overlooked by the amateur who is in a hurry to get on the air. A few moments here to make sure you have a good grade of RG-8/U coax cable and a good antenna installation will make a great deal of difference in the performance of your new GT550.

2.3 Speaker:

The audio output from the transceiver requires an 8 ohm speaker. The speaker connection is an RCA type phono jack on the rear panel. Galaxy's SC550 speaker is highly recommended. The SC550 has been designed for the GT550 for a good quality sound and comes in a matching cabinet that will also house the AC-400 power supply. For mobile installation a small separate speaker is recommended.

2.4 Microphone:

The best performance from your GT550 will result when using a wideband, flat frequency response mike.

The microphone input is a HIGH IMPEDANCE input. The best VOX (voice control) operation is experienced when the mike has a cardioid pattern to reduce background pick up. This type of mike allows you to operate your audio gain at a higher level, giving optimum VOX operation, reducing reverberation, echoes and noise pick-up in both fixed and mobile installations.

Microphones with limited low or high frequency response with peaks in the voice range, commonly used for SSB will work satisfactorily, but at somewhat less than maximum performance. Audio shaping should take place in the transceiver, not in the microphone.

A three conductor (3-circuit) microphone plug is required for the jack provided on the front panel of the GT550. A plug such as Switchcrafts S-260 or equivalent should be used. The plug and microphone are connected as shown in the illustration below --

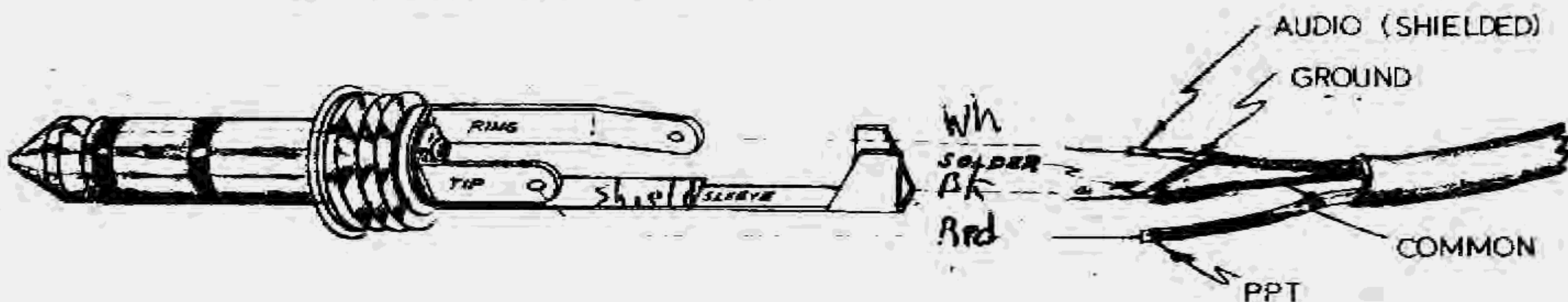

MICROPHONE CONNECTION

FIGURE 1

NOTE

Some mikes have a PTT switch wired so the mike element is shorted out when the PTT switch is in the OFF condition. When using this type of mike for VOX operation the SHORT must be eliminated or the VOX will not operate.

2.5 Power:

The main power Jack on the rear of the GT550 requires a Cinch-Jones type S-312CCT connector. This connector is part of the Galaxy AC-400 and G-1000 DC power supplies. The power plug pins are connected as shown in the illustration below --

- Pin 1 --- 850 vdc
- Pin 2 --- spare
- Pin 3 --- 350 vdc
- Pin 4 --- spare
- Pin 5 --- 12 vdc
- Pin 6 --- 12.6 vac
- Pin 7 --- Ground
- Pin 8 --- spare
- Pin 9 --- -100 vdc (bias)
- Pin 10 -- spare
- Pin 11 -- AC control
- Pin 12 -- AC Control

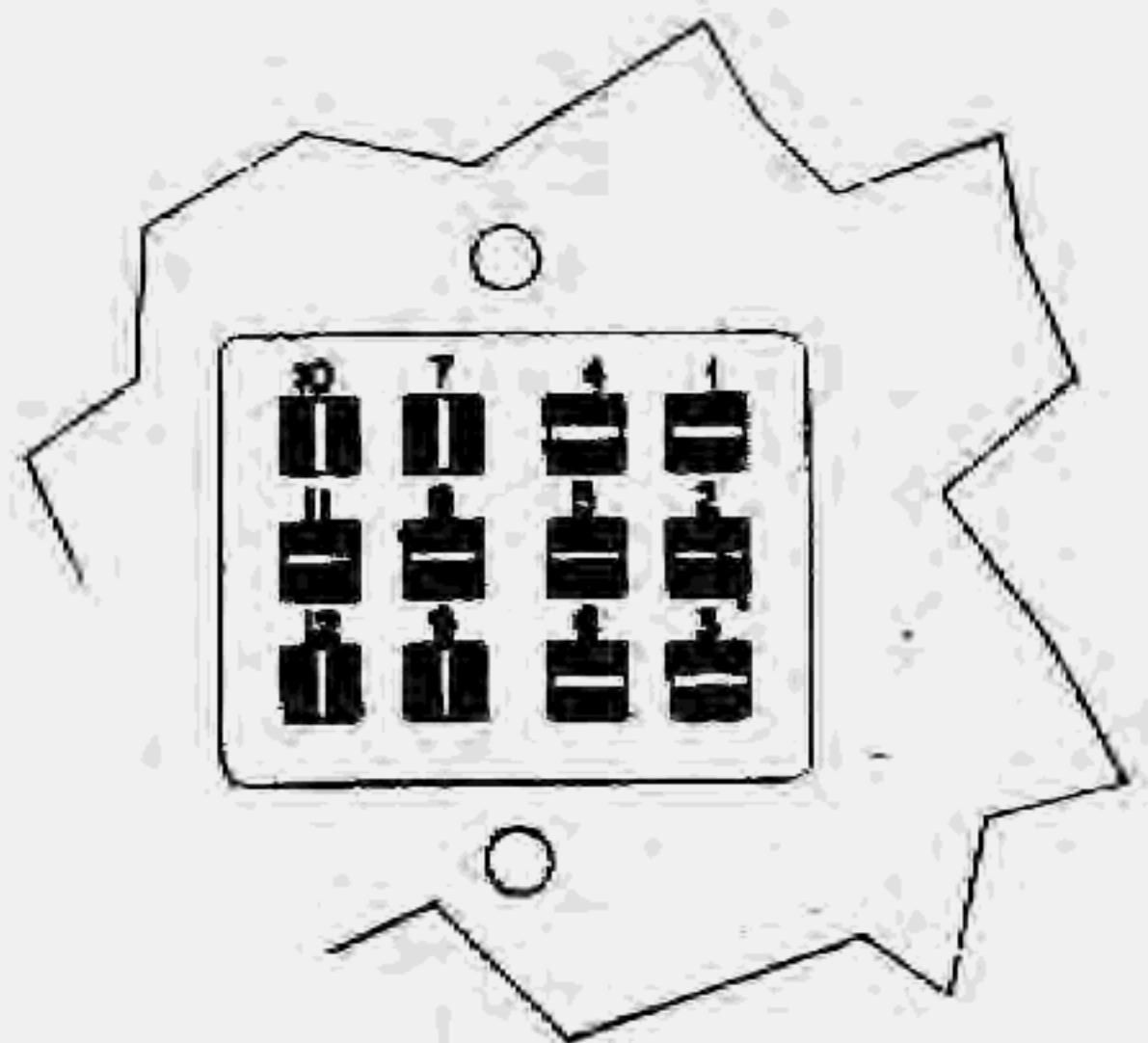

POWER PLUG CONNECTION

FIGURE 2

2.6 Location:

The location of the GT550, fixed or mobile is not critical. Care should be taken to insure that space is allowed for adequate air circulation. Locations near radiators or heating units should be avoided.

CAUTION!

DO NOT COVER THE TOP OF THE GT550 WITH BOOKS, PAPERS OR OTHER PIECES OF EQUIPMENT AS OVERHEATING MAY RESULT!

2.6.1 Fixed installation -- Galaxy's Model AC-400 power supply is required for fixed station operation. The use of the SC550 matching speaker is highly desirable and you will note from paragraph 2.3 that the AC-400 power supply will fit inside the SC550 speaker cabinet. This forms one compact unit. Figure 3 shows the proper connections between the GT550, AC-400, Speaker, Antenna and Ground. If a linear is used at your fixed station installation, such as the Galaxy LA550, it should be connected as shown in Figure 4.

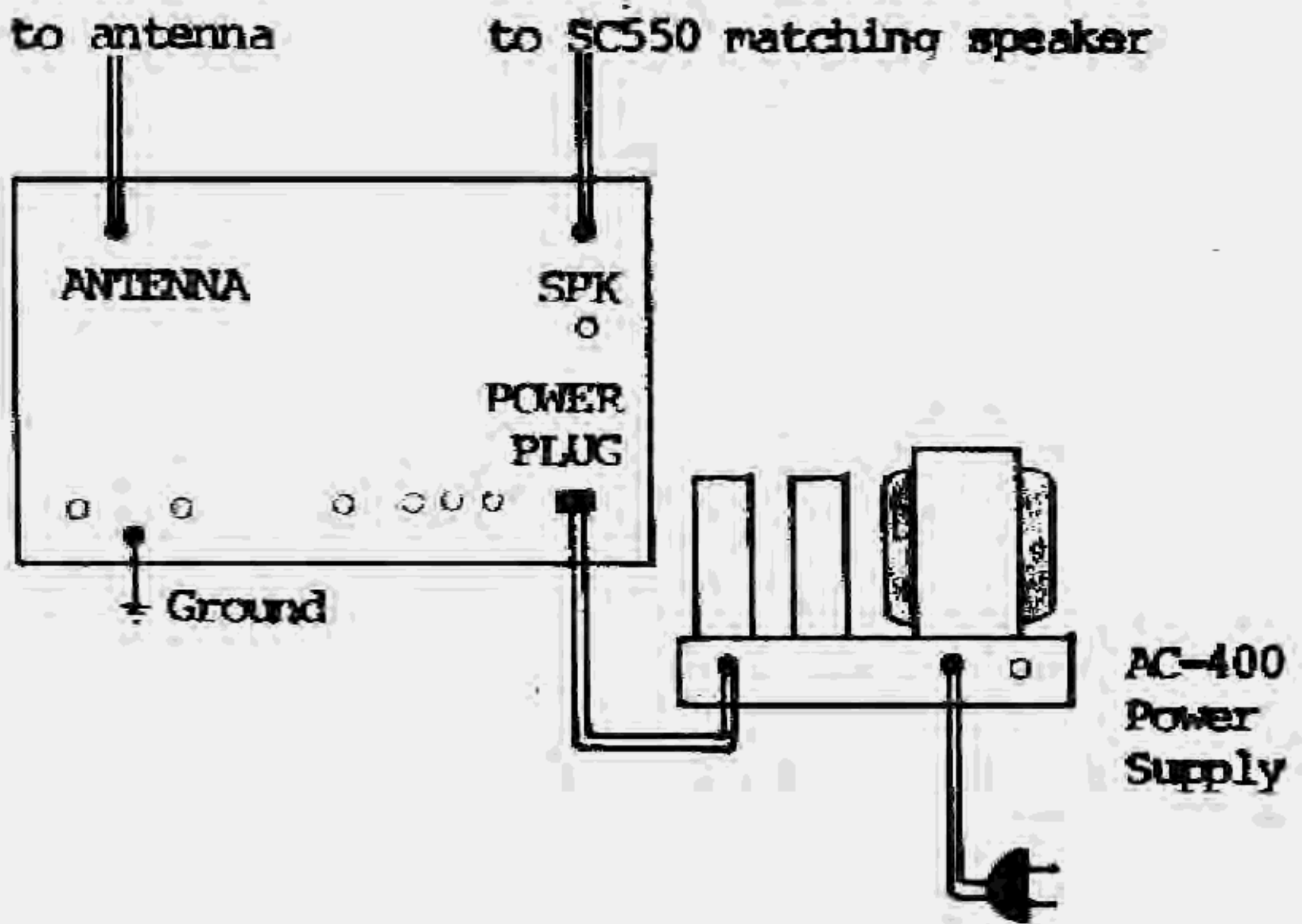

FIXED STATION CABLE CONNECTIONS

FIGURE 3

(SWR Bridge or Wattmeter)

to
SC550
Matching Speaker

to antenna

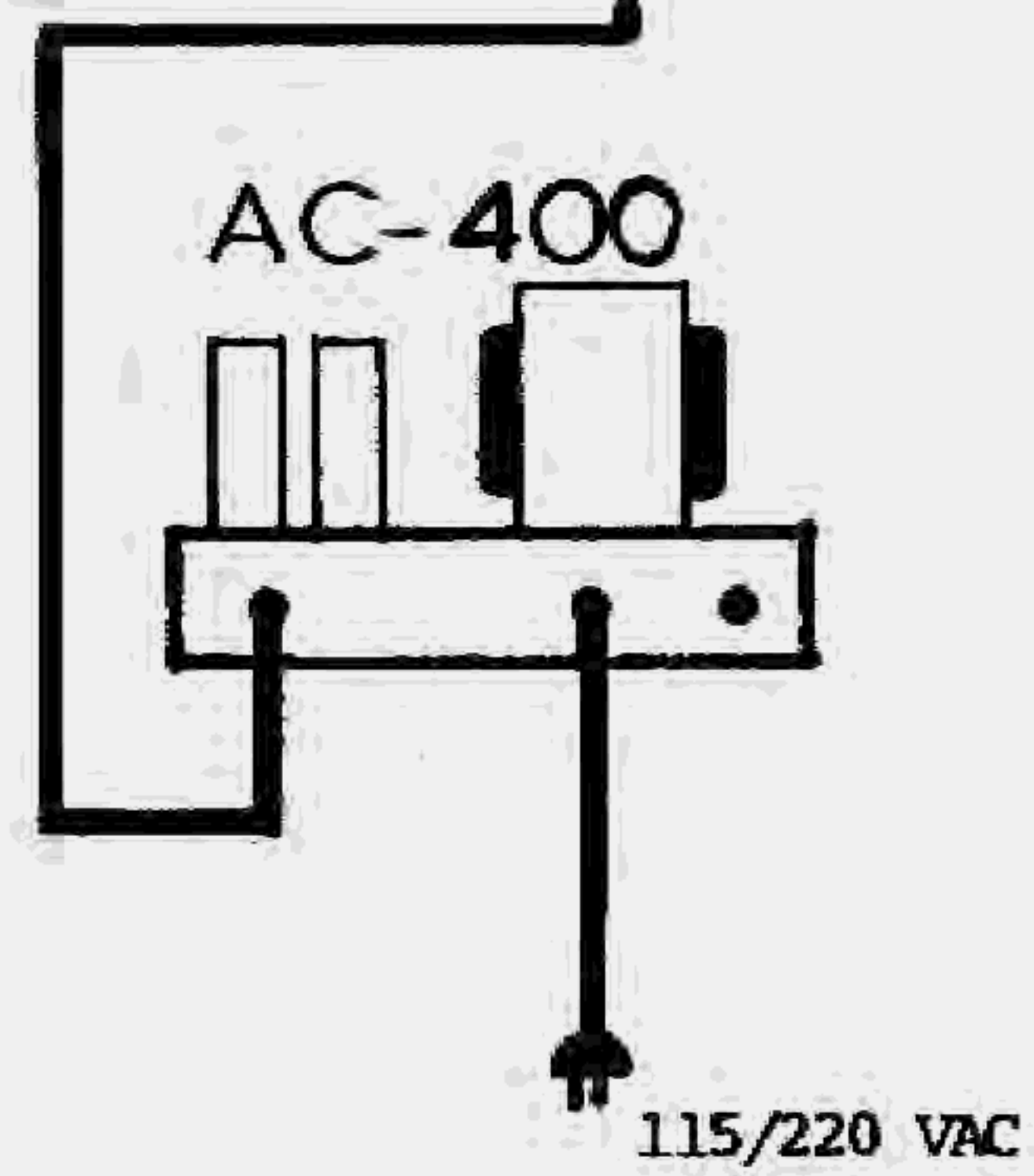
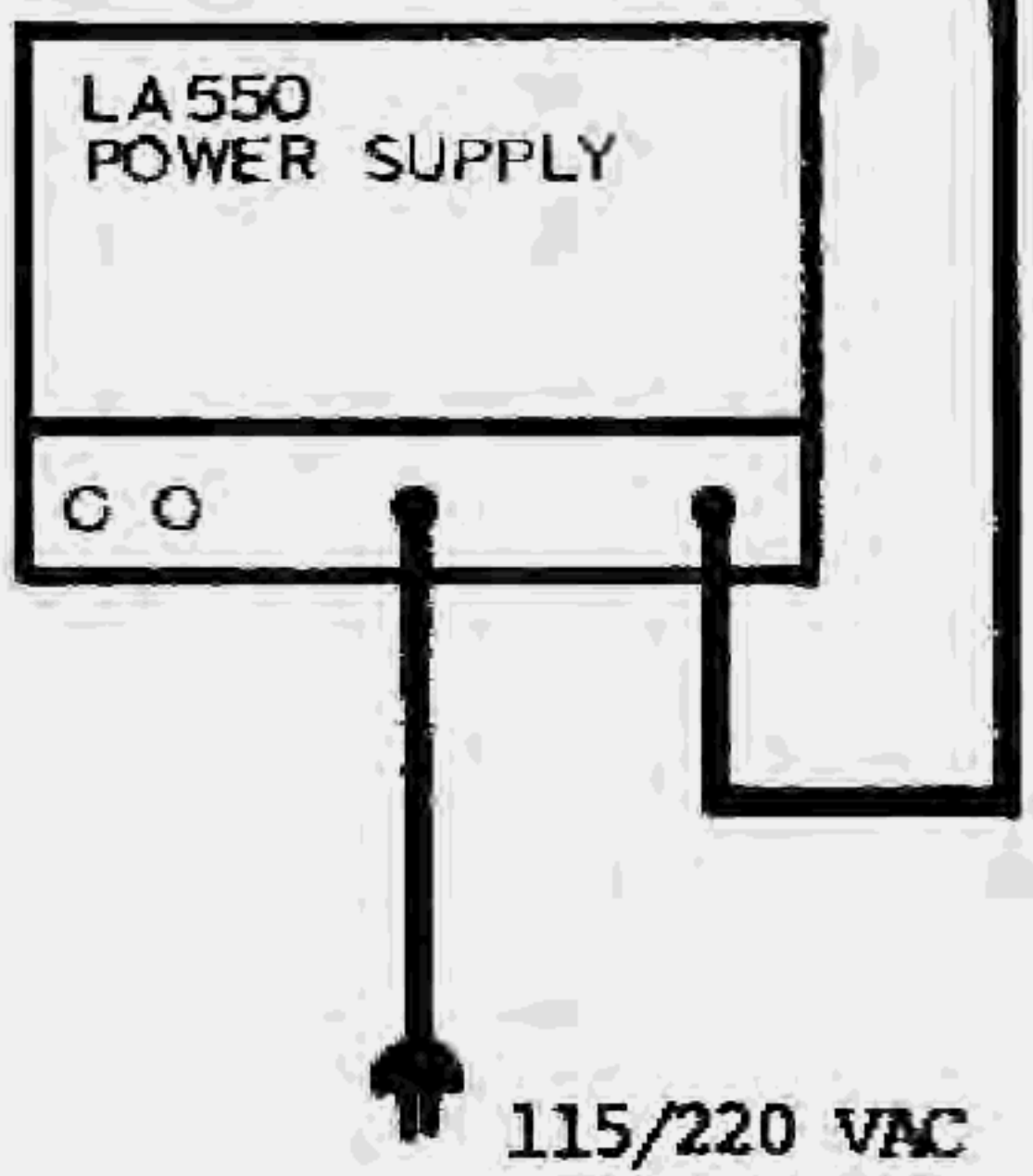
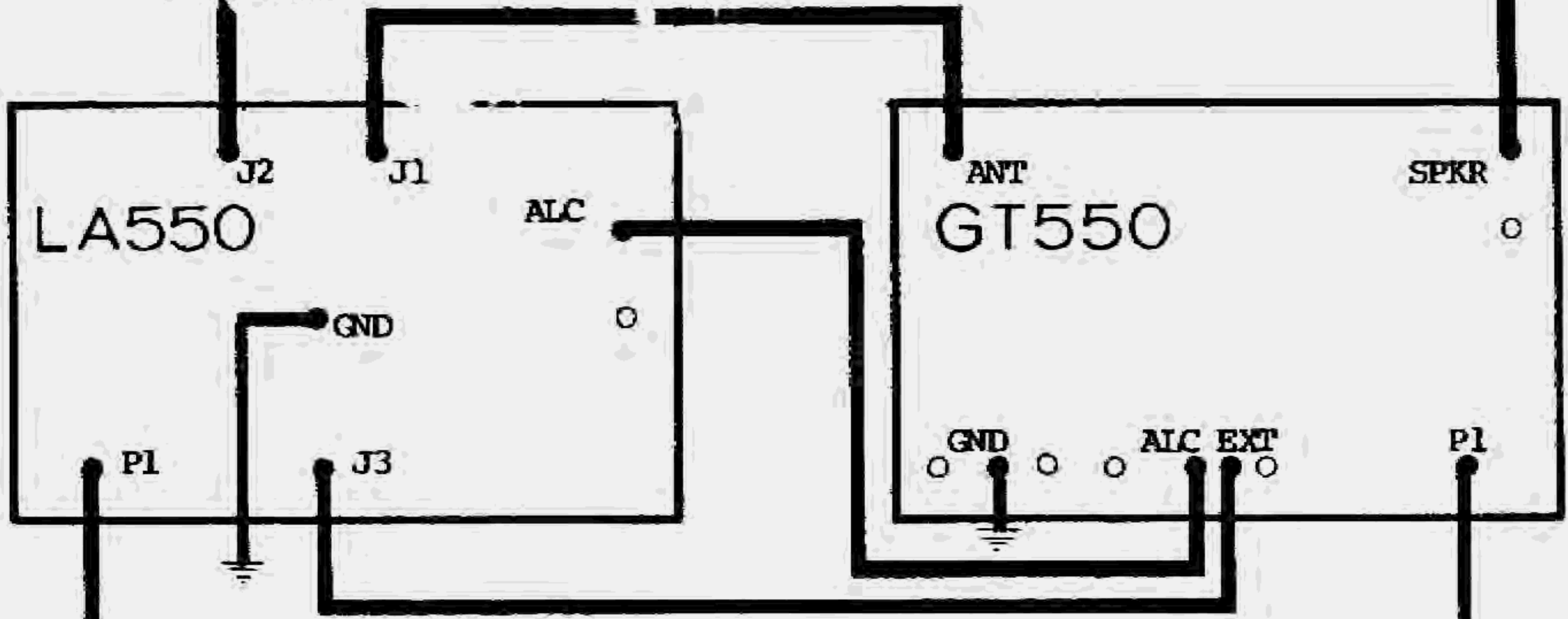

LINEAR CABLE CONNECTIONS

FIGURE 4

2.6.2 Mobile Installation -- The G-1000DC power supply will be required when using the GT550 mobile. The GT550 can be installed in any vehicle having a 12 VDC electrical system. The G-1000DC power supply is factory wired for NEGATIVE GROUND and comes with the necessary power plug for the GT550. Figure 5 below shows the proper cable connections.

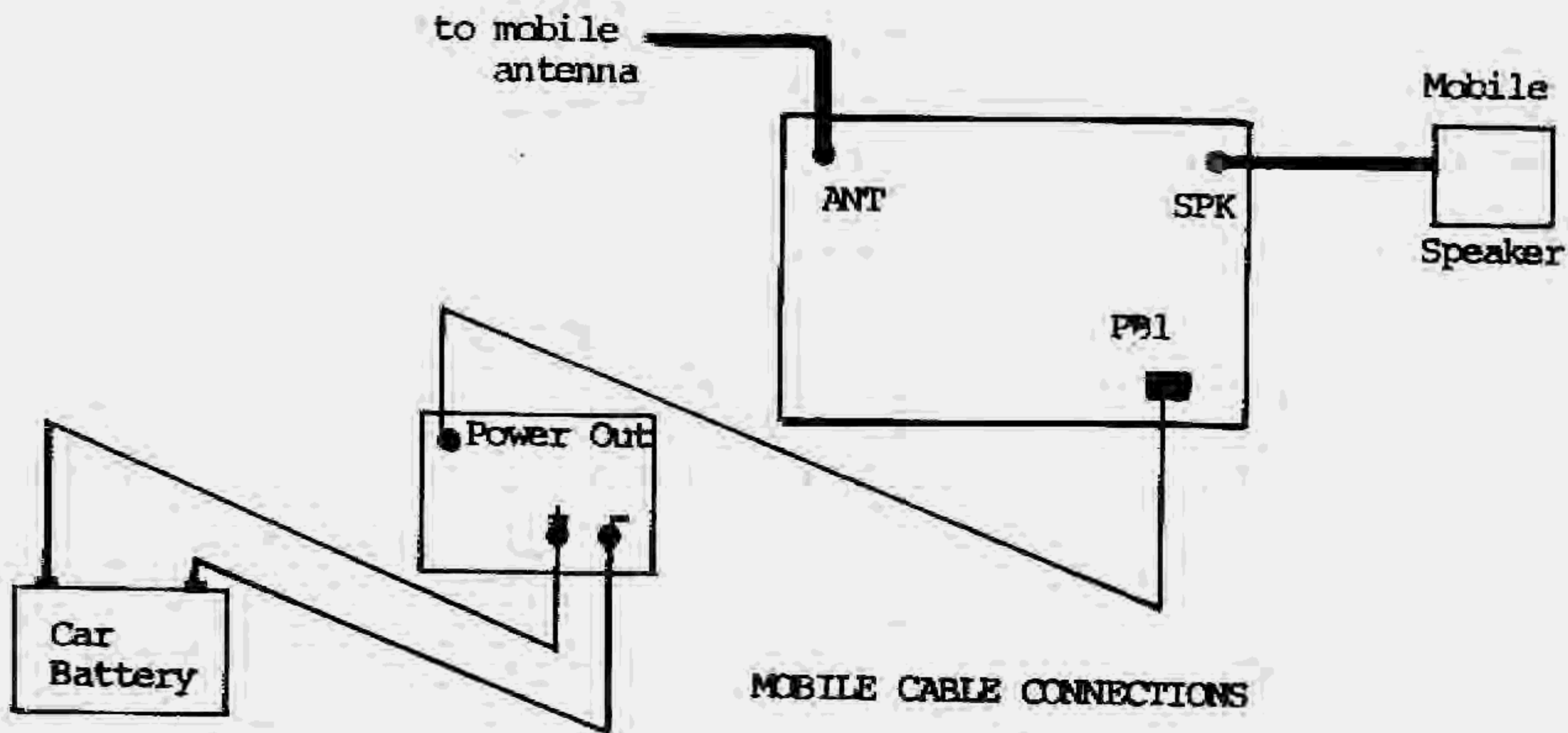

FIGURE 5

Mount the transceiver in a location under the dash using a mobile mounting bracket. Additional mounting information is provided with the mount.

2.6.3 Mobile DC Supply Considerations -- The G-1000DC power supply should be mounted as near to the battery as possible. DO NOT mount the supply in a location that would require extension of the primary cables attached to the supply.

The G-1000DC should be mounted high on the inside of the fender, near the battery. This will position it out of the direct water splash in most cases, and also in the best position for ventilation. DO NOT mount the supply near the firewall -- this is a "HEAT TRAP" in the motor compartment.

The worst condition for a DC power supply is to operate the GT550 while driving at high speed, building up considerable heat in the motor compartment, then stop for gas, etc., and turn off the motor. The heat build-up in the motor compartment under these conditions is terrific. If you find it necessary to stop and turn off the motor, the DC power supply should be SHUT DOWN until the heat level has been reduced by opening the hood, or starting the motor for added ventilation from the motor fan.

NEVER start the motor with the DC power supply in operation! Turn off the DC power supply until the motor is running.

The cable carrying power from the DC supply to the GT550 should not be over 10 feet in length. If slightly more length is necessary then an added #18 wire should be paralleled with the wire that carries the filament power. (Pin 6 on the power plug)

2.6.4 Mobile Antenna Installation -- Install a mobile antenna in the manner recommended by the antenna manufacturer and connect the coax lead from it to the antenna connector on the GT550 using a PL-259 connector. Mobile antenna installation is another item that is often overlooked and done too hastily. Take your time and read some of the many good books available on the subject -- your time will be well spent and very noticeable in your mobile performance.

2.6.5 Mobile Speaker Considerations -- If your car has an all transistor radio as most do nowadays, install a separate speaker for your mobile GT550. It should be mounted for operator convenience.

2.6.6 Ignition Noise -- In most mobile installations ignition noise becomes a problem. It is recommended that you install resistor type spark plugs and insert a 10,000 ohm suppressor resistor in the center tower of the distributor cap. A 5000 ohm suppressor resistor is suggested in each spark plug tower on the distributor cap. A coaxial capacitor at the ignition coil

primary, mounted as close to the coil terminal as possible is another MUST. If noise is still present again we suggest you consult the many articles and books written on the subject. There are also several good commercial noise suppression kits available.

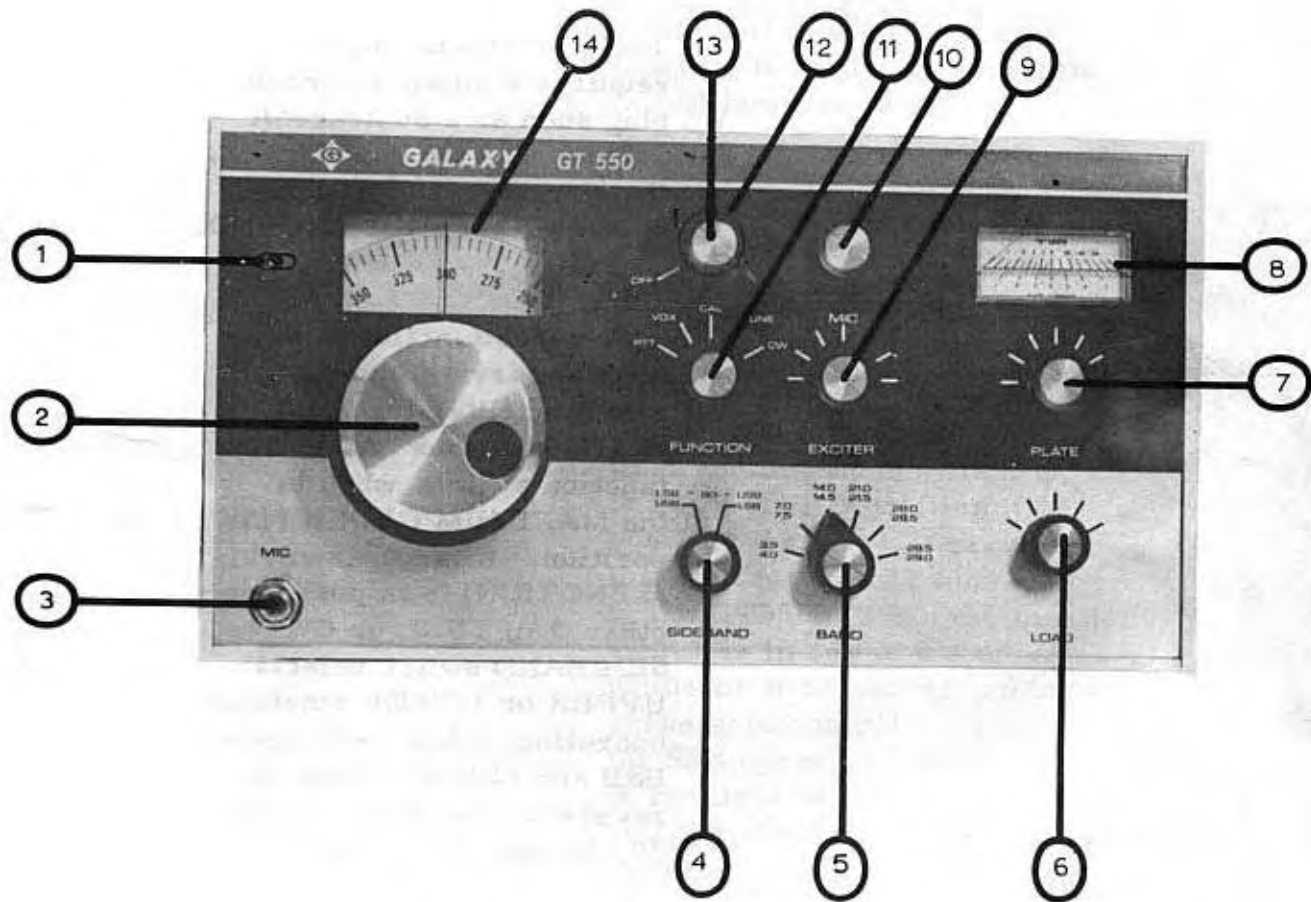

FRONT-VIEW OF THE GT550

FIGURE 6

2.7 Control Functions:

- 1 -- VFO Indicator Correction Tab
Used to calibrate the VFO dial.
- 2 -- Main Frequency Tuning Knob
Has finger hole for fast tune. 72:1 ratio for optimum tuning of SSB and CW signals.
- 3 -- MIC (Input jack)
The microphone jack requires a small 3-circuit plug such as a Switchcraft S-260. The tip is PTT, the ring is AUDIO and the sleeve or barrel is GROUND.
- 4 -- SIDEBAND Switch
Serves two functions -- inserts carrier into the passband filter for TUNE or CW positions of the function switch, when in the MAXIMUM CLOCKWISE position. When the switch (FUNCTION) is in positions other than TUNE or CW the SIDEBAND switch selects UPPER or LOWER sideband operation. Note -- 80 meter USB and LSB positions are reversed from those of 40, 20, 15 and 10 meters.
- 5 -- BAND Switch
Selects desired frequency range in 500 KHz steps.
- 6 -- LOAD
This control matches the Final Plate circuit to the Antenna Load within the range of the Pi-network. It can match resistive antenna loads from 40 to 100 ohms.

7 -- PLATE

This control tunes the Final Amplifier to resonance.

8 -- METER

This "Taut Band" meter is accurate to within 2%. In the receive function of the GT550 it serves as an "S" meter and in the transmit function it reads plate current in milliamperes.

9 -- EXCITER

This control tunes both the Final Driver and the Receiver Antenna Input circuits to resonance.

10 -- MIC

Serves two functions -- when the functions switch is in the TUNE position it controls the level of carrier inserted for proper tune-up of the GT550. When the function switch is in any of the other positions it serves as a microphone gain control. Proper setting for SSB operation is whatever is required to maintain voice peaks at approximately 300 ma on the meter.

11 -- FUNCTION Switch

A five position selector switch which controls various functions of the GT550 --- #PTT - Allows keying of the transmitter with the mike push-to-talk button. VOX will not operate when the switch is in this position.

#VOX - when in this position and the VOX accessory is installed, the transmitter is keyed by normal voice as well as push-to-talk.

#CAL - In this position the crystal calibrator accessory is turned on allowing calibration of the main tuning dial.

NOTE

DO NOT LEAVE FUNCTION SWITCH IN THE CAL POSITION FOR TRANSMIT OR RECEIVE OPERATION!

#TUNE - In this position the transmitter is placed in a transmit condition at reduced power.

NOTE

THE SIDEBAND SWITCH MUST BE IN THE MAXIMUM CLOCKWISE POSITION, AND THE MIKE GAIN CONTROL MAXIMUM CLOCKWISE see tuning procedure.

#CW - This position places the transmitter condition to FULL CW power operation - see tuning procedure.

12 -- RF GAIN CONTROL

The RF Gain Control knob is behind the AF Gain Control knob. It is normally left in the Maximum Clockwise position. For strong signals it may be set in a counter-clockwise direction to increase the AVC threshold level. As the RF Gain Control is retarded, the "S" meter level will increase and only signals of this strength or greater will move the meter.

13 -- ON-OFF SWITCH/AF GAIN CONTROL

When the AF Gain Control knob is in the Maximum Counter-Clockwise position the power to the GT550 is turned OFF. Advancing the control clockwise turns the power ON. When the power is ON the control governs the audio output (volume).

14 -- VFO MAIN TUNING DIAL

This dial is calibrated in primary marks every 5 KHz. The dial reading is added to the lower MHz number of the band you are on as noted by the pointer on the BAND switch. For example -- the frequency the GT550 in Figure 6 is tuned to would be 14.0 MHz (lower MHz reading of BAND selected) added to .300 MHz as shown on the VFO Main Tuning Dial, making the operating frequency 14.300 MHz.

REAR-VIEW OF THE GT550

FIGURE 7

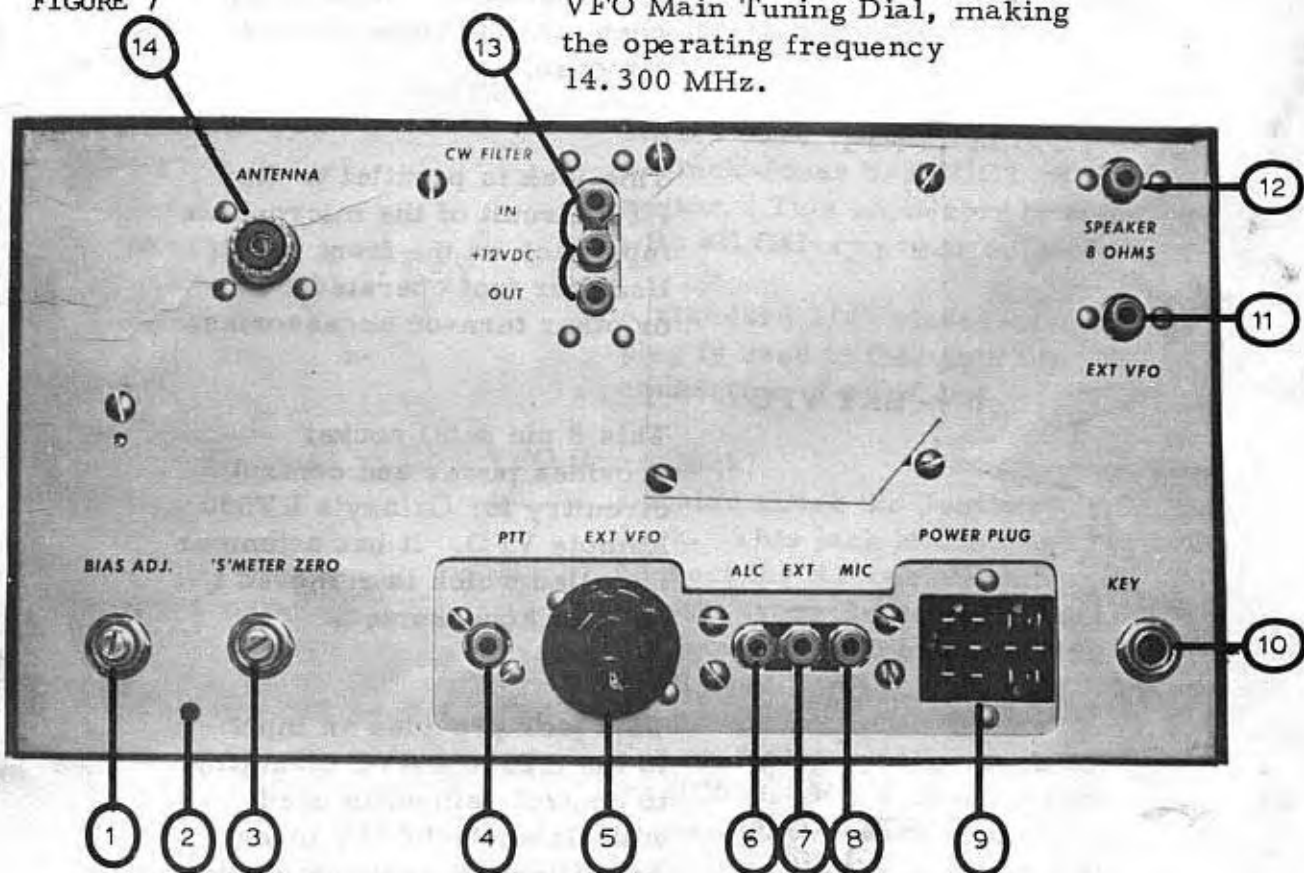

2.8 Rear Panel Controls and Jacks:

1 -- BIAS ADJ.

This control is the bias adjust potentiometer R33 used to set the bias on the final tubes.

2 -- GROUND LUG

Grounding connection for external ground. Should be connected to cold-water pipe or good outside ground for fixed-station use, or to the body chassis for mobile installations.

3 -- "S" METER ZERO

This control is the electrical "S" Meter Zero Adjustment potentiometer. Adjust only when antenna connection is removed.

4 -- PTT

This jack is parallel to the PTT circuit of the microphone input jack on the front panel. Used for foot operated PTT or other turn-on accessories.

5 -- EXT VFO

This 8 pin octal socket provides power and control circuitry for Galaxy's RV550 Remote VFO. It has a jumper installed which is removed to connect accessories.

6. --ALC

This jack provides an input to the GT550's AVC circuitry to control gain when used with Galaxy's LA550 Linear Amplifier. It assures maximum output without "FLAT TOPPING"!

7 -- EXT

This jack provides a ground on the center part of the connector when the GT550 is in the TRANSMIT mode, to allow other equipment to be used in unison with the GT550.

CAUTION!

DO NOT APPLY MORE THAN 70 VOLTS AC OR DC OR MORE THAN 1 AMP TO THIS JACK. NEVER USE THIS JACK TO KEY 115 VAC LINES.

8 -- MIC

This jack is in parallel with the microphone connection on the front panel. It is normally used for phone patch connections.

9 -- POWER

Main Power connection requires a Cinch-Jones S-312CCT connector. This connector is supplied with all Galaxy power supplies.

10 -- KEY

A standard 1/4" closed-circuit plug is used in this jack for connection of a CW key.

11 -- EXT VFO (Input Jack)

Located under the Speaker Jack. This jack is used to connect the RF cable from an accessory Remote VFO to the internal VFO of the GT550, when used.

12 -- SPEAKER 8 Ohms

For an 8 ohm speaker such as the SC550. If a 4 ohm speaker is used place a 4 ohm resistor in series with the speaker before you use the GT550 at maximum volume level.

13 -- CW FILTER

Filter IN, 12 VDC, Filter OUT--
these three jacks are for
connection of the Galaxy
F3 selective CW Filter. The
IN and OUT jacks are "shorted"
internally. To use the F3
filter this internal short/jumper
must be removed.

14 -- ANT

This SO-239 connection is the
50 ohm Antenna Input. It
requires a PL-259 plug on
your antenna coax feed line.

SECTION 3 OPERATION

3.1 General:

It is assumed that the Galaxy GT550 has been properly installed as per Section 2, whether it be fixed-station or mobile. Before operation is attempted, check to make certain that the antenna and speaker are properly connected. Check the power connection closely to make sure it is seated properly in the power input jack.

The following paragraphs are intended to provide the operator with a basic knowledge making him able to get the most out of the GT550. It is strongly recommended that the entire section be read completely before actually operating the GT550 so that the maximum benefit is derived from your new transceiver.

3.2 Ground Connection:

The very first connection, and the most important consideration is a good ground connection. A grounding lug is provided on the rear panel of the transceiver as shown in Figure 7. The AC line in the GT550 is bypassed and the lack of a ground will result in a slight "shock" between the equipment and anything grounded, unless you do have a good ground. Also, lack of a good ground will often result in improper operation in several respects, including TVI problems.

The ground should be connected to a cold-water pipe or a good outside ground. If the GT550 is mobile a ground should be secure connected to the vehicle chassis.

3.3 Bias Setting:

Place the FUNCTION SWITCH in the PTT position. Turn the GT550 ON with the AF Gain Control and

allow for a 5 minute warm-up period. After 5 minutes set the MIC gain control to a MAXIMUM COUNTER-CLOCKWISE position. Set the SIDEBAND selector switch to MAXIMUM COUNTER-CLOCKWISE. Set the BIAS potentiometer, R33 on the rear panel MAXIMUM COUNTER-CLOCKWISE, see Figure 7 for location. Close the PTT circuit and adjust the BIAS control for a 70 ma reading on the panel meter.

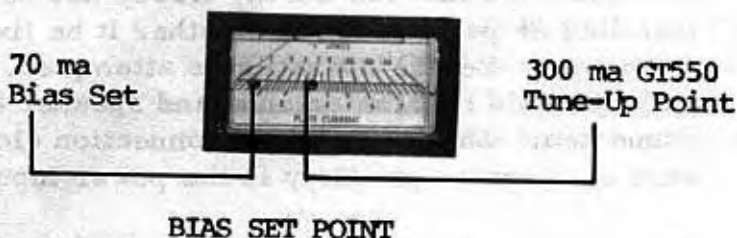

FIGURE 8

Open the PTT switch. If the line voltage changes, or when you change the GT550 from fixed-station to mobile operation be sure to reset the BIAS adjustment. If in doubt, CHECK IT!

3.4 "S" Meter Zero Set:

Set the "S" Meter Zero Adjustment, R2 located on the back panel to MID-RANGE. After the unit has been on for several minutes, disconnect the antenna, peak the exciter control for maximum noise and then adjust R2 so the "S" Meter rests on the extreme left mark on the meter face. This will allow the "S" Meter to be properly aligned for a true reading. Also, by adjusting the "S" Meter in this manner, you will be able to read atmospheric noise levels.

3.5 Accessory Installation:

3.5.1 Calibrator Installation -- To install the 25 KHz calibrator, simply remove the top cabinet from the GT550 and install the calibrator in the octal socket J2. Installation is shown below in Figure 9. Galaxy's old 100 KHz calibrator will also work (Model CAL35) by modifying the socket connections. To use the 100 KHz calibrator remove the bottom of the GT550 and perform the following steps

- 1 -- Remove the two Orange wires from pin 3 of J2 solder them together and tape them.
- 2 -- Connect a 100 K ohm resistor from pin 1 of J2 to 350 vdc. 350 vdc comes from pin 3 of P1, the power plug. Solder the 100K resistor in place.

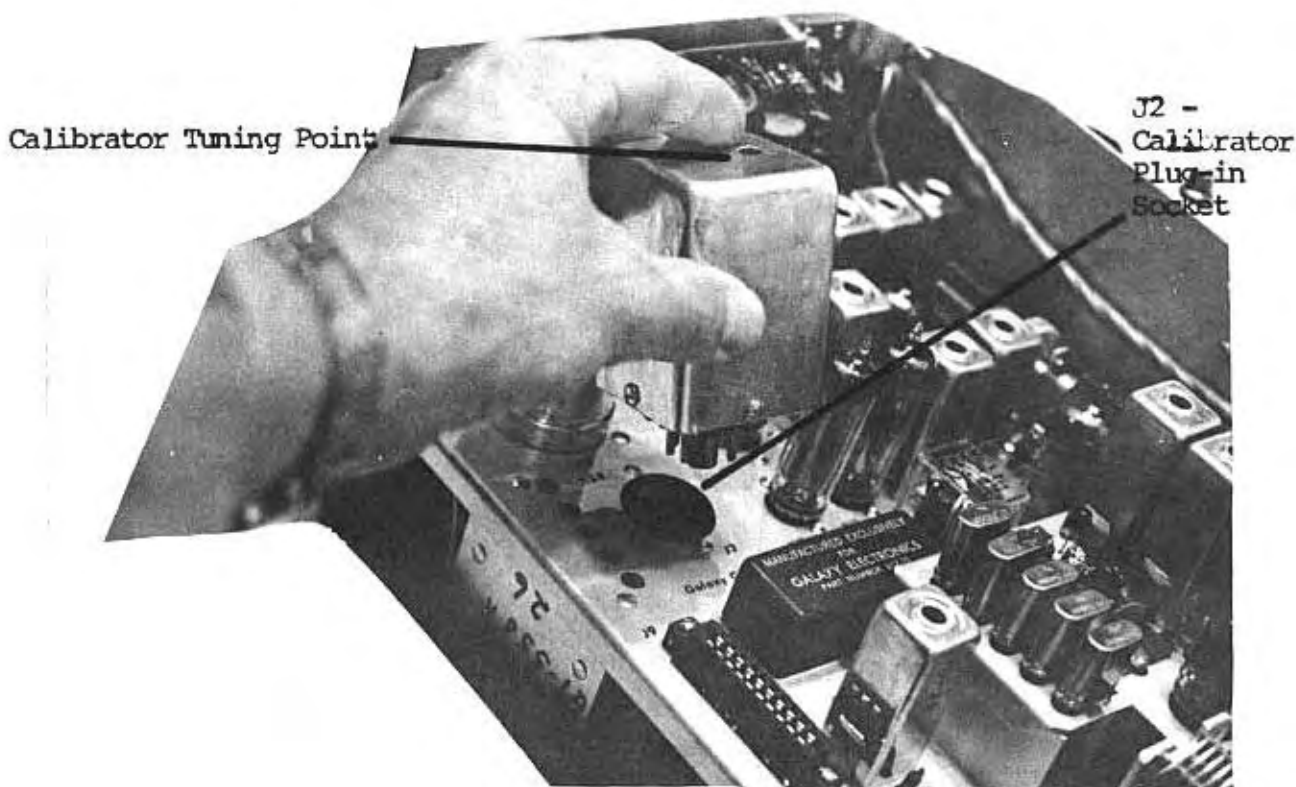

CALIBRATOR INSTALLATION

FIGURE 9

3.5.2 VOX Installation -- To install the VOX accessory make sure the AC power is OFF. Remove the top cabinet from the GT550 and remove the JUMPER STRIP now installed in J9. With the VOX positioned so the control side of the board is to the outside of the chassis, insert the VOX into the contact strip J9. Make sure it is firmly seated for good contact along its full length. Replace the GT550 cabinet top and adjust the VOX controls as called for on the VOX instruction sheet through the control adjustment holes in the side of the GT550 cabinet. Figure 10 illustrates proper installation of the VOX accessory.

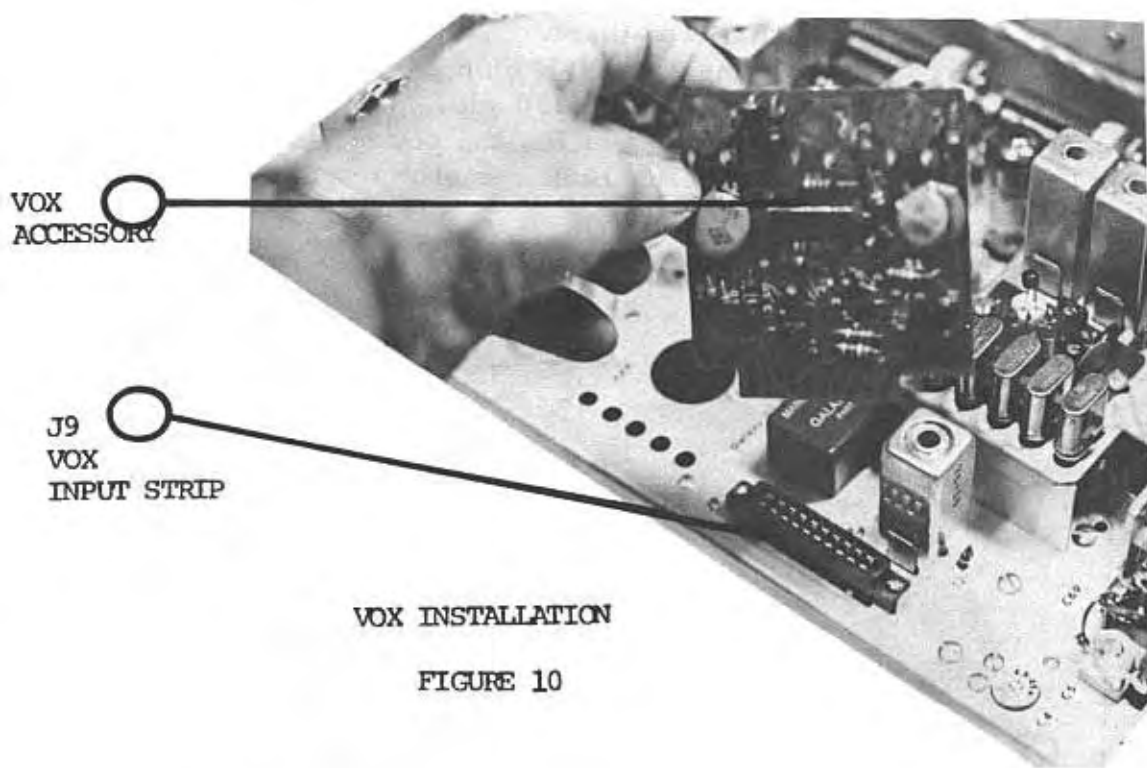

3.5.3 RV550 Remote VFO Installation --

The RV550 is installed by simply removing the JUMPER PLUG in the EXT VFO octal socket (See Figure 7) and plug the REMOTE VFO control cable into the EXT VFO socket. Plug the small cable (VFO INPUT) into the EXT VFO input located just beneath the speaker output.

3.5.4 F3CW Filter Installation -- The F3 CW Filter is easily installed, but before making any connections you must remove the top cabinet of the GT550 and clip (remove) the short between the Filter IN and Filter OUT jacks. Once this is done simply replace the top cabinet and plug the three (3) leads into the rear panel of the GT550 as marked -- Filter IN, 12 VDC and Filter OUT. See Figure 7 for location of jacks.

3.6 Receiver Operation:

Turn the GT550 ON by rotating the AF Gain Control CLOCKWISE. Allow 30 seconds for the tubes to warm up and during this period you should perform the following:

- 1 -- Place the BAND switch to the desired band.
- 2 -- Place the PLATE & LOAD controls to MID-POSITION.
- 3 -- Place the RF Gain Control to MAXIMUM CLOCKWISE.
- 4 -- Adjust the EXCITER control for MAXIMUM signal (background noise) as indicated by "S" Meter reading.

NOTE

ADJUSTMENT OF THE CONTROLS MENTIONED ABOVE WILL RESULT IN APPROXIMATE RESONANT CONDITIONS IN THE TRANSCEIVER STAGES, THEREFORE, ONE SHOULD ALWAYS PERFORM THESE OPERATIONS FIRST.

3.6.1 Receiver Tuning -- Precise tuning of a single-sideband signal is very important. Do not be satisfied to merely tune until the voice can be understood, take the time to set the fine tuning to the exact spot where the voice becomes natural.

The Galaxy GT550 transmits on exactly the same frequency as the one you have tuned the receiver to, automatically. No adjustment is necessary since the same oscillator is used for both send and receive. If separate receive and transmit frequency control is desired, such as DX HUNTING use the RV550 Remote VFO.

3.7 Transmitter Operation:

Tuning the GT550 is not difficult. If you follow the few simple steps outlined in the following paragraphs the transmitter will perform as it was designed to perform.

After the operator has become familiar with the adjustment procedure he will be able to do the adjustments quickly and from memory. However, until this familiarity is obtained, the operator should read all the steps below and do them as quickly as possible. If a step is forgotten, place the transmitter in a "STANDBY" condition (THIS IS DONE BY PLACING THE FUNCTION SWITCH TO THE PTT POSITION) and re-read the tune-up procedure. DO NOT KEEP THE TRANSMITTER ON IN AN UNTUNED CONDITION!

3.7.1 Transmitter Tuning --

- 1 -- Place the SIDEBAND selector switch in the MAXIMUM CLOCKWISE position.
- 2 -- Set the MIC gain control fully CLOCKWISE.
- 3 -- Set the LOAD control fully COUNTER-CLOCKWISE

warning note!

FCC has a ruling about unauthorized tuning ON THE AIR - it is suggested the following tuning be done with the GT550 connected to a DUMMY LOAD (Waters Model 334A or equal) rather than an antenna to minimize QRM.

- 4 -- Place the FUNCTION switch to the TUNE position.
- 5 -- Tune EXCITER control for maximum meter reading.
- 6 -- Tune the PLATE control for a dip on the meter, minimum reading.

NOTE

If a CW key is attached to the GT550 be sure it is CLOSED when accomplishing steps 4, 5 and 6.

NOTE

If the meter reading is ABOVE the 300 ma point on the meter STOP, turn the FUNCTION Switch to PTT position and check your antenna. A dip which results in a meter reading ABOVE the 300 ma point indicates antenna problems. This indication points out that the antenna impedance is below that which the pi-network can match (BELOW 40 ohms). Corrective action must be taken, such as retuning the antenna or using an antenna matching device.

If the meter reading is BELOW the 300 ma point on the meter proceed with steps 7 & 8.

- 7 -- Adjust the MIC gain control COUNTER-CLOCKWISE until the meter drops about 25%, retune the EXCITER control for a precise peak on the meter. Return the MIC gain control to a MAXIMUM CLOCKWISE setting.
- 8-- Now adjust the LOAD control CLOCKWISE until the meter rises to 300 ma on the meter. Quickly adjust the PLATE control for a dip on the meter once again. It should be a higher MINIMUM than before.

Repeat steps 5, 6, 7 & 8 until the MINIMUM meter reading after retuning the PLATE control is at 300 ma on the meter. The object being to get the last dip of MINIMUM current at the 300 ma point on the meter.

When step 8 allows the dip to appear at the 300 ma point on the meter, then tuning is complete. Return the FUNCTION switch to the PTT position.

NOTE

If the LOAD control reaches the fully clockwise position and you are unable to dip the meter to 300 ma, STOP and place the FUNCTION switch in the PTT position. This condition indicates your antenna has an impedance ABOVE that which the pi-network can match (ABOVE 100 ohms). Corrective action must be taken such as retuning your antenna or using an antenna matching device.

9 -- Assuming there was no trouble loading the antenna, the equipment is now ready to be operated on SSB or CW.

3.7.2 - CW Operation - CW operation is available in the following modes:

Low Power Manual Operation
High Power Manual Operation
VOX, "BREAK-IN" Operation

3.7.2.1 Low Power - Manual Operation --

After completion of steps 8 & 9 of paragraph 3.7.1, operate the key to send CW. When you are done transmitting, return the FUNCTION switch to PTT position. The input with the FUNCTION switch in the TUNE position for CW is approximately 250 watts. It is recommended that the microphone be un-plugged from the panel if this method is used. If you wish to reduce power for this type of operation simply set the MIC gain control in a COUNTER-CLOCKWISE direction which will reduce the power input. This may be done to obtain any power input level desired down to a fraction of a watt.

3.7.2.2 360 WATT - Manual CW Operation --

This is the HIGH POWER method normally used when the VOX is not used. The microphone should be plugged in as a convenient means of placing the transmitter in the transmit condition with the PTT switching. The setting of the MIC gain control DOES NOT control power in the CW mode. It should be set fully counter-clockwise and the FUNCTION switch placed in the CW position.

After completion of steps 8 & 9 open the key and place the FUNCTION switch in the CW position. The unit will now be in a receiving condition. To transmit, close the PTT with the microphone and operate the key for CW. Open the PTT to return to the receiving condition. (A foot switch can be connected to MIC jack or to the PTT jack on the rear panel if so desired.)

3.7.2.3 CW "BREAK-IN" Operation 360 Watt --

This method of operation requires that a VOX accessory be installed and correctly adjusted. Refer to the VOX manual for correct adjustment.

When steps 8 & 9 are completed open the key and place the FUNCTION switch to the CW mode. When the key is closed the unit will automatically go into a transmit condition. It will remain in transmit a second or two, adjustable by the "hold-time" setting on the VOX unit. After this "hold-time" the unit will automatically return to the receive state. Adjust the VOX "hold-time" as desired, however, there is a slight "click" generated in the speaker each time and to minimize this we suggest a "hold-time" of about one second.

NOTE

The GT550 is operating at a reduced power level for both TUNE & CW operation. Full power input is only available on voice SSB.

3.7.3 SSB Operation -- After tuning steps 8 & 9, return the FUNCTION switch to PTT or VOX as desired. Remember, VOX will only work if the VOX accessory is installed. Set the MIC gain to a MAXIMUM COUNTER-CLOCKWISE position. Select the desired sideband. Note the 80 meter USB and LSB settings are the reverse of 40, 20, 15 and 10 meter settings.

Place the unit in the transmit position with the PTT on the microphone or speak into the microphone and adjust the MIC gain to operate the VOX when in the VOX position. The VOX will activate the unit at any setting if properly adjusted. Adjust the VOX unit as necessary for VOX gain, Anti-VOX and Hold-Time.

While speaking into the microphone, advance the MIC gain control in a CLOCKWISE direction until the voice peaks swing the meter up to 300 ma on the meter. This represents full SSB power.

The exact setting of the MIC gain control is of no importance, it depends on the output level of the microphone in use and the volume level of the operators voice. A high output microphone may need only slight advancement of the MIC gain control (-45db is a very high output) while a microphone with a low output (-60db or more is a low output) may require the MIC gain control to be fully CLOCKWISE. Most high output microphones are prone to "peak" in the higher voice frequencies, one with an output of about -55db is a good all-round choice for SSB use. However, any microphone that will allow the unit to be drive to full input power may be used.

NOTE

YOU WILL HEAR A TONE IN THE SPEAKER OR HEAD-
PHONES WHENEVER YOU HAVE THE TRANSCEIVER
IN THE TUNE OR CW SETTINGS OF THE FUNCTION
SWITCH OR HAVE THE KEY CLOSED. THE VOLUME
OF THIS "side-tone" CAN BE REGULATED WITH THE
AF RECEIVE VOLUME CONTROL.

WARNING

Never tune the set with the FUNCTION switch in the CW position. All tuning is to be done in the TUNE position only, as indicated in paragraph 3.7.1.

3.8 Mobile Tune-Up -- Tuning is the same in all respects for mobile operation as in fixed station operation and done in accordance with paragraph 3.7.1. However, there are a couple of points of interest that should be mentioned. When changing the set from fixed-station to mobile use, be sure the BIAS setting on the final tubes is checked as described in paragraph 3.3. Reset if necessary.

Most mobile antennas are rated for SSB power only. They may fail if you operate the set in TUNE or CW for several minutes and most certainly will DE-TUNE if carrier is left on. The trick is to do your TUNING quickly!

SECTION 4

THEORY OF OPERATION

4.1 General Circuit Analysis for Transmitting:

Referring to the block diagram in Figure 11 and the schematic diagram Figure 19, you can follow the signal path as it is traced from the microphone to the pi-network when the transceiver is in the TRANSMIT mode.

The voice signal from the microphone is coupled to the two transistors on the back panel for amplification, then to the 12AT7 balanced modulator tube. A signal from the 6GX6 carrier oscillator tube is also coupled into the balanced modulator tube and this signal will be on 9001.250 KHz (SIDE BAND Switch Max. CW) or 8998.750 KHz (SIDE BAND switch Max. CCW) depending on the band in use. The audio and RF signals are combined in the 12AT7 balanced modulator tube and the resultant output is double sideband, suppressed carrier.

The double sideband, suppressed carrier signal is then coupled into the crystal lattice filter. As the filter bandpass is restricted, it only allows one of the sidebands to pass thru to it's output terminals. This completes the generation of a SSB signal and the filter output is then coupled to the 6EW6 IF amplifier stage, then to the 6EJ7 transmit mixer tube.

A signal from the VFO, in the range of 5.0 to 5.5 MHz is coupled to the transmit mixer tube for operation on the 80 meter band, or from the 6KE8 mixer tube for operation on the other bands. Output from the 6KE8 mixer tube is in the range of 16.0-16.5 MHz for 40 meters, 23.0-23.5 MHz for 20 meters, 30.0-30.5 MHz for 15 meters and 37.0-38.0 MHz for 10 meter operation. The sum or difference frequency, as required for the band of operation, is selected by the tuned circuits. This signal, along with the 9 MHz signal, is combined in the 6EJ7 transmit mixer to produce the signal on the desired operating frequency and is then coupled to the 6GK6 driver stage. The 6GK6 drives the parallel 6LB6 tubes in the output stage.

1N462 rectifiers are coupled to the grid circuit of the 6LB6 tubes and detect any trace of grid current flowing in the tubes.

This voltage is coupled as a negative ALC voltage to the 6EW6 IF amplifier stage. Thus, when grid current does flow, the gain of the 6EW6 stage is automatically reduced to maintain linearity. This reduces distortion and increases "TALK-POWER".

The plates of the 6LB6 tubes are connected in parallel and matched to the antenna output through an adjustable pi-network.

In CW operation the carrier oscillator is shifted to 8999.45 KHz for carrier insertion into the filter bandpass and the 6EJ7 is grid-block keyed.

4.2 General Circuit Analysis for Receiving:

Again referring to Figures 11 and 19, the incoming signal is switched through the antenna relay, then coupled into the 12BZ6 amplifier stage. The output of this stage is coupled to the 6HG8 receiving mixer tube. Signal from the VFO in the range of 5.0-5.5 MHz for 80 meter operation is coupled to the 6HG8 mixer tube; or in the range of 16.0-16.5 MHz for 40, 23.0-23.5 MHz for 20, 30.0-30.5 MHz for 15 and 37.0-38.0 MHz for 10 meter operation.

The output of the 6HG8 is coupled to the 9 MHz crystal filter, with the bandpass of this filter determining selectivity. The output of the filter is coupled to the 6EW6 IF amplifier; it is then coupled to the 12BA6 second IF amplifier and then to the 6GX6 product detector tube.

6GX6 is low-level audio, and this output is coupled to the AVC rectifier and audio amplifier. The AVC rectifier's negative DC output voltage is coupled to the first RF stage and the first and second IF amplifier stages, controlling the gain of these stages. The audio from the 6GX8 is amplified by a couple of amplifier stages.

The output from the last driver operates a complimentary pair of transistors which delivers audio to the speaker.

NOTE

This transceiver was designed for optimum performance using an 8 ohm PM speaker such as Galaxy's SC550. A 3 or 4 ohm speaker can be used, but distortion will be very noticeable at high volume levels. Placing a 4 ohm resistor in series with the speaker will minimize distortion but will also result in a loss in volume.

4.3 VOX Circuit Analysis:

VOX (Voice Operated Control) is an optional plug-in unit as shown by the dotted lines on the block diagram, Figure 11.

A portion of the audio is taken from the second microphone amplifier and coupled to the first VOX amplifier stage which drives the second VOX amplifier. When the input reaches the zener diode reference level, this pre-set level through a pair of transistors "triggers" the relay amplifier. This "trigger" circuit is much more positive in action than the usual VOX circuitry and will minimize any "chattering".

When operating CW, the keying circuit operates the sidetone oscillator and it injects a strong audio signal to operate the VOX for "break-in" action. When using the VOX for CW you will find operation better if the VOX gain is set HIGHER and the ANTI-VOX gain set set LOWER than when using it for voice operation.

The ANTI-VOX circuitry can reject unwanted signals only to a degree, and excess audio from the speaker may cause the VOX unit to cycle on and off.

BLOCK DIAGRAM GT550

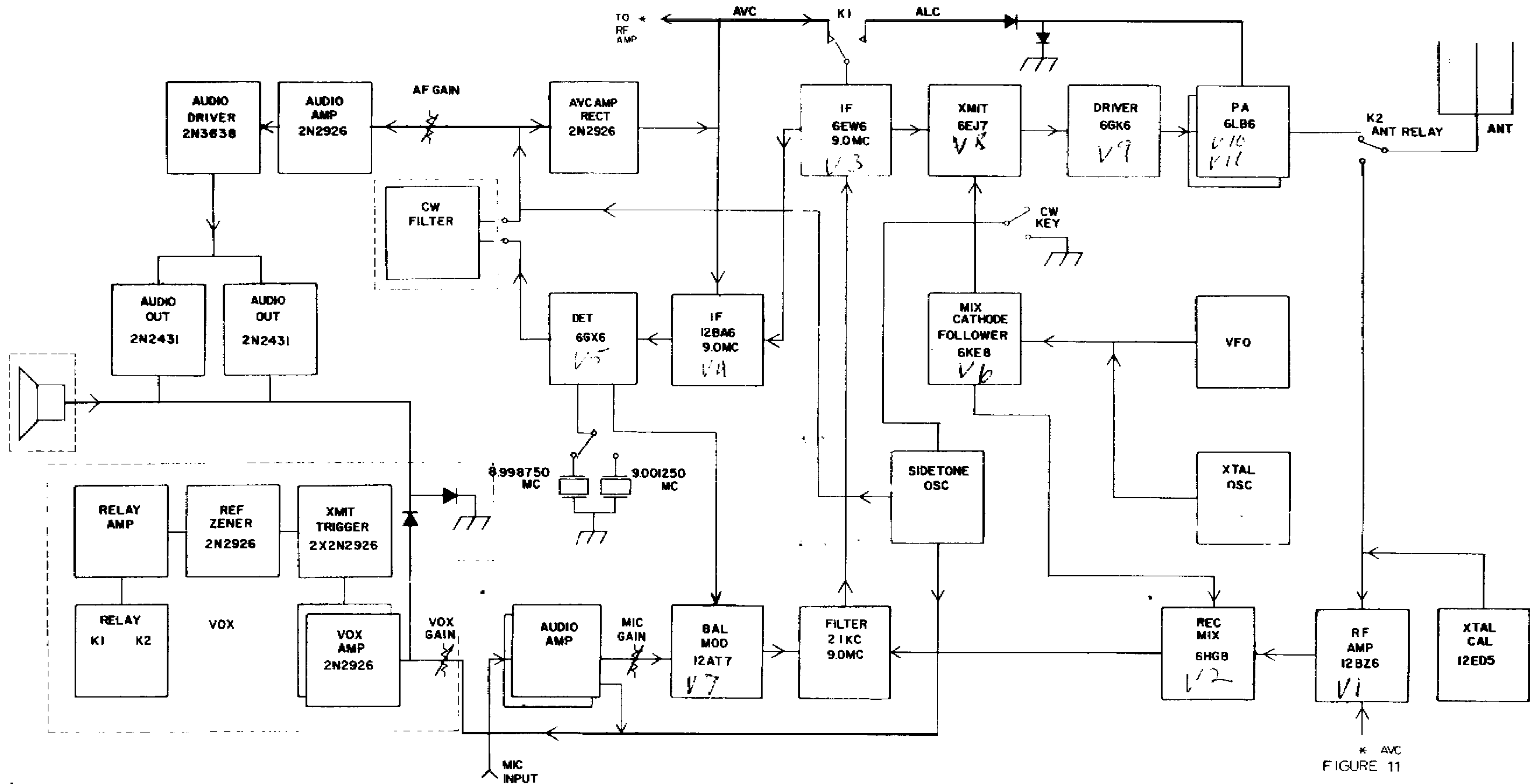

- Plug-in acc. not included with

* AVC
FIGURE 11

The three proper steps to stop this are --

- 1 -- Reduce the speaker volume
- 2 -- Increase ANTI-VOX
- 3 -- Decrease VOX gain

Remember keeping the microphone further from the speaker has the same result as the lowering of the audio level.

4.4 VFO Tuning Dial:

The VFO main tuning dial illuminated and has an adjustable indicator. The dial, main tuning knob and the VFO indicator correction tab are shown in Figure 12 below. The primary calibration marks on the dial are every 5 KHz. The dial reading should be added to the lower MHz frequency which the band switch is positioned to. For example, in Figure 12 below the frequency would be 7.280 MHz. 7.0 being the low side of the 7.0-7.5 frequency range the BAND switch is on and .280 MHz being the reading on the dial.



FIGURE 12

SECTION 5

TEST AND ALIGNMENT

5.1 General:

The following procedures are given in order to perform proper alignment of the GT550.

Alignment should not be undertaken unless the operator has adequate test equipment and has a full understanding of the circuitry.

CAUTION!

High Voltages exist at exposed components when the GT550 is out of the cabinet. Use **EXTREME** caution as voltages are dangerous to life!

5.2 Test Equipment Required:

The following test equipment is recommended for use during the alignment procedures, spelled out in this section.

- 1 -- Calibrated RF Signal Generator
- 2 -- Crystal Calibrator 25 KHz or 100 KHz
- 3 -- 1000 Watt Dummy Load with output meter
- 4 -- Output Indicator, such as an oscilloscope
- 5 -- Calibrated Audio Generator
- 6 -- Calibrated VTVM with RF probe
- 7 -- Set of alignment tools

5.3 Alignment:

5.3.1 IF Amplifier Alignment -- Proceed with the following steps:

- 1 -- Remove the VOX or Jumper Board from J9, this will prevent the unit from being placed in the transmit condition accidentally.
- 2 -- Set the controls as follows:
 - RF GAIN fully clockwise
 - FUNCTION switch in the PTT position
 - LOAD control at 10 o'clock position

- PLATE control at 12 o'clock position
- BANDSWITCH to the 40 meter band 7.0-7.5 MHz
- 3 -- Connect the RF Signal Generator to the antenna jack (ANTENNA)
- 4 -- Set the AF gain control 1/2 open and allow 5 minutes for the receiver to warm-up.
- 5 -- Adjust the R2 potentiometer, "S" Meter Adj on the back panel for a 0 reading on the "S" meter.
- 6 -- Set the RF Signal Generator for 10,000 microvolts output at 9.0 MHz then vary the generator frequency slightly until a beat note is heard in the speaker. Adjust the PLATE tuning for MAXIMUM "S" Meter reading. Adjust the Sig. Gen. output level until the "S" Meter reads approximately S6.
- 7 -- Adjust the slug in L13 (Figure 14) and the slug in T1 (Figure 14) for MAXIMUM "S" Meter reading.
- 8 -- Adjust the slug in L1 the 9 MHz trap for MINIMUM "S" Meter reading.
- 9 -- This completes the IF Amplifier Alignment

5.3.2 VFO Alignment & Tracking -- Proceed with the following steps:

- 1 -- Set the controls as follows:
 - RF gain control fully clockwise
 - FUNCTION switch to the CAL position if you do not have a calibrator, use an external source, but the accuracy of alignment depends on the accuracy of the reference signal.
 - Set the BANDSWITCH to the 80 meters 3.5-4.0 MHz
 - Set the EXCITER control to 10 o'clock
 - Set the SIDEBAND selector to MAX. CCW
 - Set the VFO indicator to center using VFO indicator correction tab (Figure 12).
- 2 -- Adjust main tuning dial slightly to find 4.0 MHz signal.
- 3 -- Adjust L19 and Main Tuning Dial until ZERO BEAT note and calibrator signal occur at 4.0 MHz on the dial.
- 4 -- Set the Main Tuning dial to 3.5 MHz
- 5 -- Adjust C5 and Main Tuning dial until ZERO BEAT note and calibrator signal occur at 3.5 MHz.

- 6-- Repeat steps 2 thru 5 until tuning dial is at exactly 3.5 and 4.0 MHz respectively.
- 7-- Plug VTVM into test point 1 on chassis (Figure 14) place VTVM on 3 volt RMS scale.
- 8-- Set Main Tuning dial to 3.750 MHz (.250 on dial)
- 9-- Ground SWAMP "C" on T2 (Figure 14)
- 10-- Adjust bottom slug on T2 for MAXIMUM output on VTVM.
- 11-- Remove ground on SWAMP "C" and ground SWAMP "D" (Figure 14) on T2.
- 12-- Adjust top slug on T2 for MAXIMUM output on VTVM.
- 13-- Remove ground from SWAMP D.
- 14-- Vary VFO dial from 0 to .500. The output should be 1.4 volts RMS or HIGHER across the entire tuning range.

5.3.3 Converter Alignment -- Proceed with the alignment as follows, using the illustration in Figure 15 below as a guide to location of the alignment and swamping points.

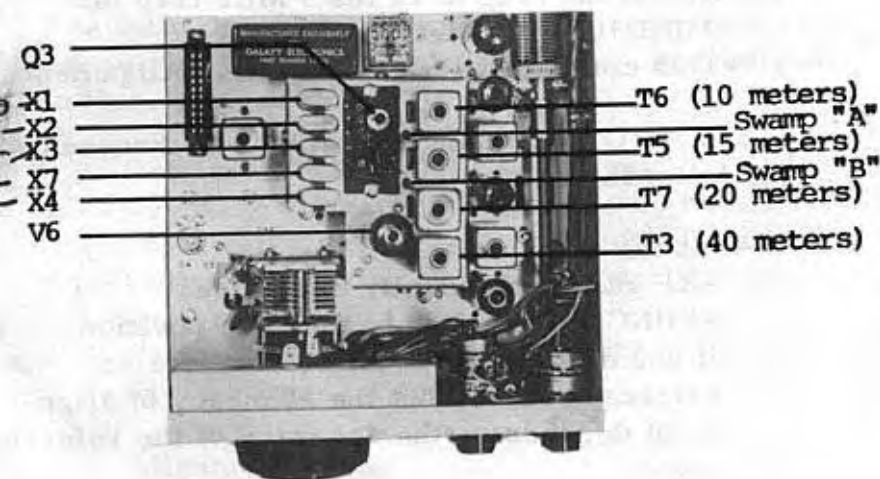

CONVERTER ALIGNMENT IDENTIFICATION

FIGURE 13

This unit has built-in swamps for T3, T5, T6 and T7. It is only necessary to ground the appropriate swamp with a screwdriver for alignment.

CW Filter Input/Output
Internal Short see
Paragraph 3.5.4

8 ohm
Speaker
Output

Antenna

Test
Point (1)

K2

Swamp "D"

Swamp "C"

L1.8

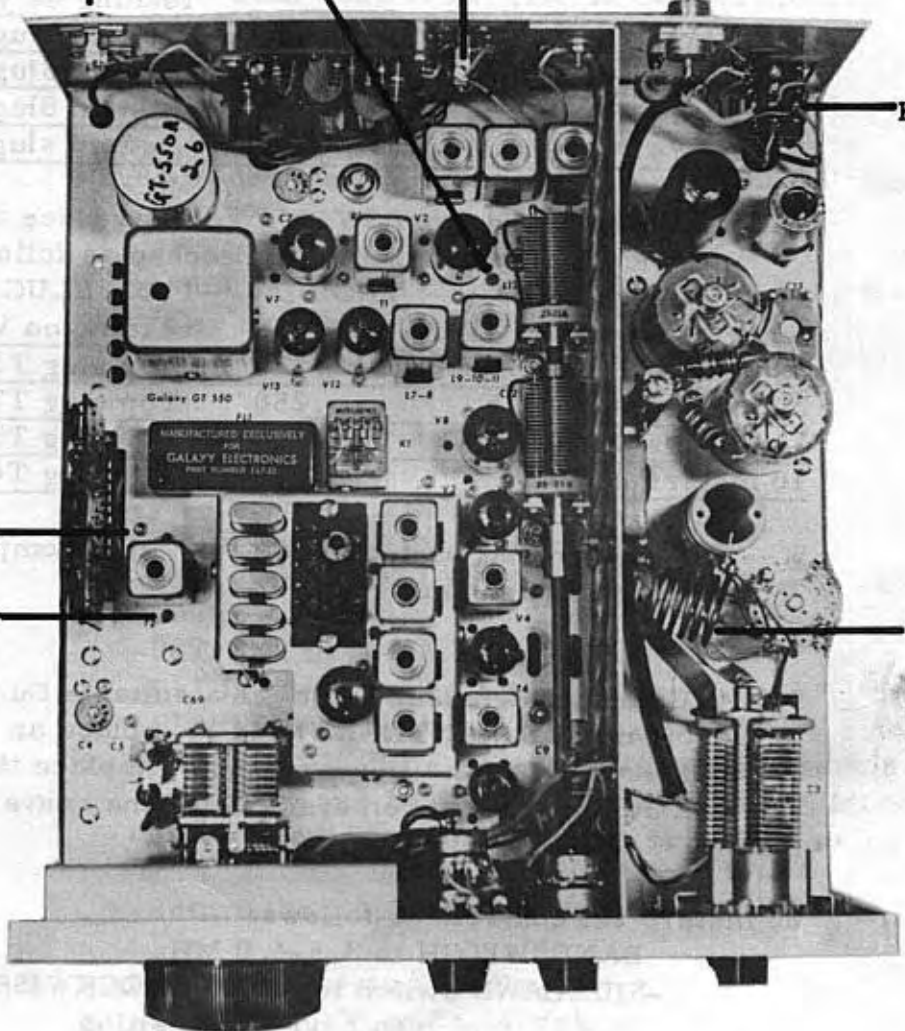

TOP VIEW OF GT550

FIGURE 14

1 -- Plug VTVM into TEST POINT 1 (Figure 14) and set VTVM to 3 volts RMS scale.

2 -- Adjust as follows:

BANDSWITCH	VFO DIAL	GROUND SWAMP "A" Tune slug for MAX. reading on VTVM
40 meters 7.0-7.5 MHz	.250	Bottom Slug T3
20 meters 14.0-14.5	.250	Bottom Slug T7
15 meters 21.0-21.5	.250	Bottom Slug T5
10 meters 28.0-28.5	.500	Bottom slug T6

3 -- Remove ground from SWAMP "A" and place the ground on SWAMP "B", then proceed as follows:

BANDSWITCH	VFO DIAL	TUNE SLUG FOR MAX. reading on VTVM
40 meters 7.0-7.5	.250	Top slug T3
20 meters 14.0-14.5	.250	Top slug T7
15 meters 21.0-21.5	.250	Top slug T5
10 meters 28.0-28.5	.500	Top slug T6

5 -- Remove ground from SWAMP "B", this completes the converter alignment.

5.3.4 Exciter Alignment -- Attach a suitable Dummy Load to the antenna jack (ANTENNA) and also place an RF indicator device across the Dummy Load. Replace the VOX or the VOX Jumper Board removed during the converter alignment.

80 meters set controls as follows:

- BANDSWITCH to 3.5-4.0 MHz
- SIDEBAND switch to MAX. CLOCKWISE
- PLATE tuning to 2 o'clock position
- LOAD control to 10 o'clock position
- MIC gain MAXIMUM COUNTER-CLOCKWISE
- VFO dial to .500 (4.0 MHz)
- EXCITER control to 9 o'clock position
- FUNCTION switch to TUNE

Advance the MIC gain control until the meter rises to "s-5" on the meter.

Adjust L2 and L7 (bottom slugs) for maximum meter reading. Use the MIC gain control to keep the "S" meter reading under S-5.

Return the FUNCTION switch to PTT.

40 meters set controls as follows:

- BANDSWITCH to 7.0-7.5 MHz
- PLATE tuning to 12 o'clock
- LOAD contr-1 to 10 o'clock
- MIC Gain Control MAXIMUM COUNTER-CLOCK-WISE
- VFO dial to .500 (7.5MHz)
- EXCITER tuning to 9 o'clock
- FUNCTION switch to TUNE
- Advance the MIC Gain Control until the "S" Meter rises to S-5.
- Adjust L3 and L8 (top slugs) for MAXIMUM meter reading, using the MIC Gain Control to keep the meter reading below S-5.
- Return the FUNCTION switch to PTT

10 meters set controls as follows:

- BANDSWITCH to 28.0-28.5 MHz
- PLATE control to 10 o'clock
- LOAD control to 11 o'clock
- MIC Gain Control MAXIMUM COUNTER CLOCK-WISE
- VFO dial to 0 (28.0 MHz)
- EXCITER tuning to 3 o'clock
- FUNCTION switch to TUNE
- Advance MIC Gain Control until meter reads S-5
- Adjust L6 and L1 (bottom slugs) for MAXIMUM meter reading, keeping meter below S-5 using the MIC Gain Control
- Return the FUNCTION switch to PTT

15 meters set controls as follows:

- BANDSWITCH to 21.0-21.5 MHz
- PLATE tuning to 10 o'clock
- LOAD control to 11 o'clock
- MIC Gain Control MAXIMUM COUNTER-CLOCK-WISE
- VFO dial to 21.0 MHz
- EXCITER tuning to 3 o'clock
- FUNCTION switch to TUNE
- Advance MIC Gain Control until S-Meter reads S-5
- Adjust L5 and L10 (Middle slugs) for MAXIMUM meter reading using the MIC Gain Control to keep meter reading under S-5.
- Return FUNCTION switch to PTT

20 meters set controls as follows:

- BANDSWITCH to 14.0-14.5 MHz
- PLATE tuning to 11 o'clock
- LOAD control to 11 o'clock
- MIC Gain Control MAXIMUM COUNTER-
WISE
- VFO dial to \emptyset (14.0 MHz)
- EXCITER tuning to 3 o'clock
- FUNCTION switch to TUNE
- Advance MIC Gain Control until meter rises to S-5
- Adjust L4 and L9 (top slugs) for MAXIMUM meter
reading, keeping meter below S-5 with Mic Gain
Control.
- Return FUNCTION switch to PTT

5.3.5 Carrier Suppression Adjustment-

- 1 - Attach an RF output indicator and Dummy Load
- 2 - Set BANDSWITCH to 7.0-7.5 MHz. Set VFO anywhere.
- 3 - Tune-up transmitter normally (See paragraph 3.7.1)
then place FUNCTION switch to PTT and MIC Gain
Control to MAXIMUM COUNTER-CLOCKWISE
- 4 - Close MIC PTT switch
- 5 - Adjust output indicator for good indication
- 6 - Observe power output level on indicator used
- 7 - Adjust C7 and R1 for minimum power output. These
two adjustments interact and should be repeated
several times.
- 8 - Set SIDEBAND selector switch to opposite side and
observe carrier remaining, if any. If any remains,
C7 and R1 may have to be re-set for a compromise
to obtain best suppression on both sidebands.

5.3.6 Carrier Crystal Alignment --

- 1 - Set-up the same paragraph 5.3.5, steps 1 thru 3, then
select SB1.
- 2 - Connect an accurately calibrated audio signal generator
to the MIC jack. Also, connect a SPST toggle switch to
the PTT circuit front or rear jacks.
- 3 - Set the audio generator to 1000 Hz with .02 volts output
- 4 - Close the PTT circuit with the toggle switch and adjust
the MIC Gain for a meter reading of S-9.
- 5 - Observe the exact reading of the output indicators used
- 6 - Change the audio generator to exactly 350 Hz and, if
necessary, adjust C9 until the output indicator shows
exactly 1/2 the reading it did before. Open the PTT
switch.

- 7 - Switch SIDEBAND selector MAXIMUM CLOCKWISE and repeat steps 3, 4 and 5.
- 8 - Change the signal generator to exactly 350 Hz and, if necessary, adjust C8 until the output indicator shows exactly 1.2 the output it did before.
- 9 - Open the PTT, Disconnect the signal generator and PTT toggle and connect the microphone as usually done.
- 10 - Repeat the Carrier Adjustment, paragraph 5.3.5 completely.

5.3.7 Final Amplifier Neutralization --

- 1 - Set the BANDSWITCH to the 28.0-28.5 MHz range
- 2 - Set the VFO dial to .500 (28.5 MHz)
- 3 - Do a normal tune-up as given in paragraph 3.7.1, then set the FUNCTION switch to CW and close the PTT switch.
- 4 - Rock the PLATE tuning slightly to either side and observe if the MAXIMUM power output on the indicator occurs exactly at the "DIP", or MINIMUM plate current on the meter. If this does not occur, adjust C13 slightly until the "DIP" and MAXIMUM power output occur together.
- 5 - OPEN the PTT circuit and set the FUNCTION switch to PTT position.

5.3.8 VFO Sideband Shift Adjustment -

- 1 - Set BANDSWITCH to 3.5-4.0 MHz
- 2 - VFO to 3.8 MHz
- 3 - RF Gain Control MAXIMUM CLOCKWISE
- 4 - Audio level and other functions for receiving with SIDEBAND selector MAXIMUM COUNTER-CLOCKWISE
- 5 - Turn FUNCTION switch to CAL position, or inject an external source of strong, unmodulated, stable rf signal for EXACT zero beat
- 6 - Change SIDEBAND selector switch to MAX CLOCKWISE position and adjust C4 for EXACT zero beat again.

5.4 Trouble Shooting Chart:

SYMPTOM	PROBABLE CAUSE
<p>GT550 will not energize (no dial lights or filaments)</p>	<ul style="list-style-type: none"> 1 - Power Supply NOT PLUGGED INTO 110 VAC 2 - POWER CABLE between power supply and GT550 not securely in place 3 - Fuse blown in Power Supply
<p>NO BACKGROUND NOISE (receiver audio)</p>	<ul style="list-style-type: none"> 1 - Speaker not plugged in 2 - CW Filter Jumper cut and jacks not jumpered 3 - Unit in transmit mode 4 - Audio Gain fully COUNTER-CLOCKWISE
<p>BACKGROUND NOISE but no signals being heard</p>	<ul style="list-style-type: none"> 1 - Antenna not attached to GT550 rear panel. Check to make sure it is connected 2 - Antenna is presenting a mismatch 3 - Antenna or antenna connector grounded out 4 - Q1 open and no 12 VDC to oscillator circuits, check V1, V4, V2, V5 & V6 5 - Remote VFO plug not plugged into J1 or the jumper has been removed from the plug
<p>GT550 performs normally on 80 and 20 meters but dead on 40, 15 & 10</p>	<p>Check V6 and Q3</p>

GT550 performs normally on all bands but.....

40, check X1
20, check X7
15, check X2
28.0-28.5, check X3
28.5-29.0, check X4

Receive is normal but will not TRANSMIT

1 - Keying line open at J3, check all cathodes in the transmit string to be sure they are being grounded. Check tubes V3, V5, V6, V7, V8, V9, V10, V11

No Modulation but GT550 TUNES normally

1 - CW key plugged into rear of unit (J3) and is not being shorted for SSB operation
2 - Check Q9, Q10 or C120, C123, C126, C127

Carrier on SSB Signal

✓ NO AT 7

1 - V7 is bad, replace and use AMPEREX ONLY
2 - R1 and C7 needs adjustment, see paragraph 5.3.5

No Sidetone

Check Q11, D9 and D10

Receive Sensitivity LOW

Check V1 and V4

Transmit Drive LOW

Check V3, V6, V8 & V9

Drive is ample, but
unable to load to
300 mA

1 - V10 & V11 soft and
require replacement (USE
GE SELECTED TUBES ONLY)
These tubes available from
Galaxy only!
2 - Possible antenna
impedance problems see
paragraph 2.2

FM-ing while MOBILE and
drifts when engine
speeded up

Voltage regulator in car
not set high enough --
set to 13.5 VDC

GT550 RESISTANCE READINGS

FIGURE 15

V1 - 12BZ6	3.3 meg	47	0	.6	60k	45k	0	-	-	-	-	-
V2 - 6HG8	150	100k	150	.6	.4	100k	110k	60k	110k	-	-	-
V3 - 6EW6	3.3 meg	47	.6	.4	55k	100k	0	-	-	-	-	-
V4 - 12BA6	3.3 meg	0	.4	0	60k	45k	100	-	-	-	-	-
V5 - 6GK6	2.2 meg	1k	.4	0	280k	110k	22k	-	-	-	-	-
V6 - 6KE8	65k	10k	150k	.4	0	65k	100	470	100	-	-	-
V7 - 12AT7	30k	130k	inf.	.4	0	30k	0	inf.	4	-	-	-
V8 - 6EJ7	inf.	330k	inf.	0	.4	0	60k	100k	0	-	-	-
V9 - 6GK6	inf.	22k	0	.4	.6	inf.	60k	100k	0	-	-	-
V10- 6LB6	0	.5	23k	0	7.8k	0	0	0	7.8k	0	23k	0
V11- 6LB6	0	.5	23k	0	7.8k	0	0	0	7.8k	0	23k	0
V12- 0B2	0	inf.	-	inf.	0	-	inf.	-	-	-	-	-
V13- 0C2	inf.	0	inf.	0	inf.	inf.	0	-	-	-	-	-

All resistance readings taken with power dis-connected.
 Readings taken with VTVM with at least 11 megohms input resistance.
 GT550's controls as follows: RF gain control MAXIMUM CLOCKWISE,
 AF gain control MID-RANGE, 40 meters, 7.2 MHz and FUNCTION switch
 in PTT position. VOX and CALIBRATOR accessories are removed and
 the VOX jumper strip installed.
 All measurements made from chassis ground to the pin designated.

GT550 Tube Voltage Chart

FIGURE 16

	1	2	3	4	5	6	7	8	9	10	11	12
V1 - 12BZ6	-0.5	0.5	-	-	300	100	0	-	-	-	-	-
	0	83	-	-	275	210	-	-	-	-	-	-
V2 - 6HG8	0.9	-0.1	1	-	-	-0.8	45	300	45	-	-	-
	83	-95	83	-	-	0	0	0	0	-	-	-
V3 - 6EW6	-0.4	0.6	-	-	285	175	0	-	-	-	-	-
	-0.4	0.6	-	-	285	175	0	-	-	-	-	-
V4 - 12BA6	-0.4	0	-	-	300	110	1.2	-	-	-	-	-
	0	0	-	-	300	210	83	-	-	-	-	-
V5 - 6GX6	-0.45	4	#6.3	-	100	150	0	-	-	-	-	-
	-0.45	3.5	-	-	115	150	0	-	-	-	-	-
V6 - 6KE8	200	-0.8	115	-	-	150	0.9	5	-	-	-	-
	180	-0.9	105	-	-	145	0.8	5	-	-	-	-
V7 - 12AT7	-0.1	0	75	-	-	-0.1	0	75	0	-	-	-
	180	0	3.5	-	-	180	0	3.5	-	-	-	-
V8 - 6EJ7	70	0	70	-	-	0	300	300	0	-	-	-
	3	0	3	-	-	0	280	170	0	-	-	-
V9 - 6GK6	75	0	0	-	-	0	365	365	-	-	-	-
	5	0	0	-	-	0	355	235	-	-	-	-
V10- 6LB6	-	0	0	0	-62*	0	0	0	-62*	0	0	-
	-	.015	180	0	-62*	0	0	0	-62*	0	180	-
V11--6LB6	-	0	0	0	-62*	0	0	0	-62*	0	0	-
	-	.015	180	0	-62*	0	0	0	-62*	0	180	-
V12- 0B2	-	-	-	-	-	-	-	-	-	-	-	-
	180	75	-	75	180	-	75	-	-	-	-	-
V13- 0C2	-	-	-	-	-	-	-	-	-	-	-	-
	75	-	-	-	75	-	-	-	-	-	-	-

#Indicates reading taken on AC volt scale

* Indicates reading varies with the bias setting potentiometer and must be properly set by the operator to be correct.

All readings taken with a VTVM, the GT550 is set in the following manner: 40 meters, 7.2 MHz, PTT FUNCTION, RF gain control MAXIMUM CLOCKWISE,, the AF gain control MID-RANGE.

Top line readings are taken in the RECEIVE MODE.

Bottom line readings are taken in the TRANSMIT MODE (PTT circuit closed)

	Emitter	Base	Collector
Q1	15	15	11
Q2	4.4	3.8	15
Q3	.55	.6	11
Q4	3.3	3.8	15
Q5	11	15	16
Q6	16	11	10.8
Q7	10.8	10.6	0
Q8	-13.5	-13.5	-0.3
Q9	1.7	2.4	8.8
Q10	11.7	12.2	25
Q11**	-10.2	-3.7	-17
Q12	1.4	2	6
Q13	.13	0.6	3
Q14	3.5	3	0
Q15	1.3	2	11
Q16	28.5	28.5	28

** Reading taken in the TRANSMIT MODE same as voltage reading. All other readings taken in RECEIVE MODE on 40 meters, 7.2 MHz with RF Gain Control MAXIMUM CLOCKWISE, AF Gain control MID-RANGE and MIC gain fully COUNTER-CLOCKWISE. Use a good VTVM with at least 11 megohms input resistance.

GT550 TRANSISTOR VOLTAGE CHART

FIGURE 17

SECTION 6

PARTS LIST

C1.	.001 mfd	20-24
C2.	.01 mfd	20-5
C3.	300 pf PA Tune	25-15
C4.	5-25 pf VFO Shift	26-6
C5.	3-15 pf VFO Track	25-24
C6.	33 pf	22-7
C7.	5-25 pf Carrier Balance	26-6
C8.	5-25 pf Carrier Xtal Adj.	26-6
C9.	5-25 pf Carrier Xtal Adj.	26-6
C10.	10 pf	20-27
C11.	140 pf Exciter Tune Driver Plate	25-21A
C12.	140 pf Exciter Tune Driver Grid	25-21B
C13.	22 pf PA Neut.	25-11A
C14.	1100 pf PA Loading	25-10A
C15.	.005 mfd	20-3
C16.	.01 mfd 1.6 KV	20-29
C17.	.01 mfd	20-5
C18.	.1 mfd 200 VDC	23-7
C19.	.005 mfd	20-3
C20.	.001 mfd	20-24
C21.	.001 mfd	20-24
C22.	.001 mfd	20-24
C23.	.001 mfd	20-24
C24.	.001 mfd	20-24
C25.	82 pf	22-48
C26.	50 pf	22-11
C27.	47 pf	22-30
C28.	.001 mfd	20-24
C29.	.001 mfd	20-24
C30.	Deleted	
C31.	Deleted	
C32.	.005 mfd	20-3
C33.	100 pf	22-21
C34.	33 pf	22-7
C35.	18 pf	22-24
C36.	.001 mfd	20-24
C37.	.005 mfd	20-3
C38.	10 pf	20-27
C39.	.005 mfd	20-3
C40.	250 pf	22-45
C41.	18 pf	22-24
C42.	33 pf	22-7
C43.	100 pf	22-21
C44.	.001 mfd	20-24
C45.	100 mfd 150 VDC	24-41
✓ C46.	2000 pf	22-27
C47.	.01 mfd	20-5

C48.	25 pf	20-8
C49.	.005 mfd	20-3
C50.	.005 mfd	20-3
C51.	.01 mfd	20-5
C52.	100 pf	22-21
C53.	560 pf	22-36
C54.	150 pf	22-26
C55.	.01 mfd	20-5
C56.	.01 mfd	20-5
C57.	.001 mfd	20-24
C58.	.01 mfd	20-5
C59.	.01 mfd	20-5
C60.	.001 mfd	20-24
C61.	1000 pf	22-19
C62.	1000 pf	22-19
C63.	.01 mfd	20-5
C64.	1000 pf	22-19
C65.	.1 mfd	20-38
C66.	6.8 pf TCN	Selected
C67.	68 pf NPO	20-67
C68.	15 pf N 750	20-65
C69.	VFO Tuning	25-17A
C70.	330 pf N750	20-66
C71.	6.8 pf NPO	20-64
C72.	100 pf	20-23
C73.	.001 mfd	20-24
C74.	.001 mfd	20-24
C75.	.001 mfd	20-24
C76.	82 pf	22-48
C77.	39 pf	22-8
C78.	150 pf	22-26
C79.	.01 mfd	20-5
C80.	.01 mfd	20-5
C81.	.01 mfd	20-5
C82.	100 mfd	29-13
C83.	100 pf	22-21
C84.	.001 mfd	20-24
C85.	.01 mfd	20-5
C86.	.001 mfd	20-24
C87.	10 pf	22-37
C88.	50 pf	22-11
C89.	470 pf	20-39
C90.	.001 mfd	20-24
C91.	50 pf	22-11
C92.	50 pf	22-11
C93.	.01 mfd	20-5
C94.	.01 mfd	20-5

C95.	.005 mfd	20-3
C96.	.001 mfd	20-24
C97.	100 pf	22-21
C98.	.001 mfd	20-24
C99.	.01 mfd	20-5
C100.	40 mfd 450V	24-21
C101.	.005 mfd	20-3
C102.	4.7 pf	20-53
C103.	39 pf	22-8
C104.	.01 mfd	20-5
C105.	100 pf	20-23
C106.	.01 mfd	20-5
C107.	220 pf	22-23
C108.	50 pf	22-11
C109.	.001 mfd	20-24
C110.	.005 mfd	20-3
C111.	.001 mfd	20-24
C112.	.001 mfd	20-24
C113.	.01 mfd	20-5
C114.	1000 pf Feed-thru	22-28
C115.	.01 mfd	20-5
C116.	.001 mfd	20-24
C117.	.47 mfd	23-18
C118.	.1 mfd	20-38
C119.	.01 mfd	20-5
C120.	.01 mfd	20-5
C121.	.1 mfd	20-38
C122.	470 pf	20-39
C123.	.01 mfd	20-5
C124.	2 mfd	29-12
C125.	.05 mfd	20-57
C126.	.01 mfd	20-5
C127.	.01 mfd	20-5
C128.	.1 mfd	20-38
C129.	.01 mfd	20-5
C130.	.001 mfd	20-24
C131.	.001 mfd	20-24
C132.	500 pf	20-37
C133.	43 pf	22-29
C134.	500 pf	20-37
C135.	62 pf	22-9
C136.	.005 mfd	20-3
C137.	.1 mfd	20-38
C138.	.02 mfd	20-39
C139.	.22 mfd	23-17
C140.	.01 mfd	20-5
C141.	.01 mfd	20-5
C142.	10 mfd	29-14

C143.	100 mfd	29-13
C144.	.01 mfd	20-5
C145.	.22 mfd	23-15
C146.	.01 mfd	20-5
C147.	.01 mfd	20-5
C148.	.01 mfd	20-5
C149.	.01 mfd	20-5
C150.	.01 mfd	20-5
C151.	.01 mfd	20-5
C152.	.01 mfd	20-5
C153.	.01 mfd	20-5
C154.	.01 mf	20-5
C155.	.01 mfd	20-5
C156.	.01 mfd	20-5
C157.	.01 mfd	20-5
C158.	.005 mfd	20-3
C159.	100 mfd	29-2
C160.	.01 mfd	20-5
C161.	180 pf	22-52
C162.	220 pf	22-23

R1.	2.5K Pot	13-7
R2.	50K Pot	13-8
R3.	2K 10w	16-20
R4.	4.7K 1w	11-4
R5.	2.2K	10-31
R6.	27K 1w	11-12
R7.	33K 2w 5%	12-24
R8.	100 ohm 1w — 8-96	11-16
R9.	10 ohm 1w 5% —	11-22
R10.	10 ohm 1w 5%	11-22
R11.	1K	10-42
R12.	1K	10-42
R13.	1000 ohm 1w — 1000 1w 8-75	11-29
R14.	3.920K	19-6
R15.	2.5K Pot	13-26
R16.	120K	10-76
R17.	10 ohm 1w	11-22
R18.	22K	10-6
R19.	10K	10-56
R20.	10K	10-56
R21.	10K	10-56
R22.	100K	10-32
R23.	6.8K	10-15
R24.	270 ohm	10-68
R25.	39K 2w	12-21

R26.	330 ohm	10-28
R27.	1.5K	10-3
R28.	6.8K	10-15
R29.	1K	10-42
R30.	1K	10-42
R31.	6.8K	10-15
R32.	100 ohm 5%	10-19
R33.	7.5K Pot	13-12
R34.	1.5K 5%	10-20
R35.	6.8K 5%	10-21
R36.	470 ohm	10-53
R37.	100K	10-32
R38.	1.8K	10-17
R39.	6.8K	10-15
R40.	33K	10-65
R41.	330 ohm	10-28
R42.	330 ohm	10-28
R43.	5.6K	10-83
R44.	1K	10-42
R45.	2.2K	10-31
R46.	33K	10-65
R47.	12K	10-84
R48.	10K 3w	19-1
R49.	470 ohm	10-53
R50.	100 ohm	10-7
R51.	22K 2w	12-9
R52.	10K	10-56
R53.	100 ohm	10-7
R54.	100K	10-32
R55.	4.7K	10-36
R56.	470 ohm	10-53
R57.	47 ohm	10-29
R58.	330 ohm	10-28
R59.	1.5K	10-3
R60.	2.2K	10-31
R61.	330 ohm	10-28
R62.	10K Pot (incl. R110)	13-31
R63.	330K	10-69
R64.	330K	10-69
R65.	10K	10-56
R66.	800 ohm 10W	16-7
R67.	10K Pot	13-23
R68.	22K	10-6
R69.	39K	10-92
R70.	100K	10-32
R71.	68K 2w	12-16
R72.	1K	10-42
R73.	2.2m	10-2
R74.	220K	10-4

R75.	47K	10-13
R76.	47K	10-13
R77.	1m	10-10
R78.	1K	10-42
R79.	100 ohm	10-7
R80.	100K	10-32
R81.	1K	10-42
R82.	47K	10-13
R83.	47ohm	10-29
R84.	220 ohm	10-58
R85.	100K	10-32
R86.	47K 2w	12-11
R87.	27K 2w	12-14
R88.	150 ohm	10-42
R89.	100K	10-32
R90.	3.3K	10-59
R91.	6.8K	10-15
R92.	100K	10-32
R93.	10K	10-56
R94.	10K	10-56
R95.	47 ohm	10-29
R96.	47K	10-13
R97.	3.3m	10-57
R98.	220K	10-4
R99.	15K 1w	11-2
R100.	1.5K	10-3
R101.	47 ohm	10-29
R102.	10K	10-56
R103.	10K	10-56
R104.	220K	10-4
R105.	1.5K	10-3
R106.	270K	10-12
R107.	1.5M	10-89
R108.	1.5M	10-89
R109.	10K	10-56
R110.	100K Pot (Part of R62)	See R62
R111.	10K	10-56
R112.	270K	10-12
R113.	3.3K	10-59
R114.	560 ohm	10-67
R115.	10K ½w	10-56
R116.	100K	10-32
R117.	1.5K	10-3
R118.	1.5K	10-3
R119.	1K	10-42
R120.	15K	10-81
R121.	10K	10-56

R122.	10K Pot (incl. R126/54)	13-18
R123.	1K	10-42
R124.	47K	10-13
R125.	33K	10-65
R126.	4.7M	10-70
R127.	50K Pot (part of R122) <i>AF POT</i>	See R122
R128.	560 ohm	10-67
R129.	1.5K	10-3
R130.	10K	10-56
R131.	15K	10-81
R132.	39K	10-92
R133.	1.5K	10-3
R134.	1K	10-42
R135.	2.7K	10-66
R136.	820hm	10-87
R137.	1 ohm 1 watt	11-23
R138.	1 ohm 1 watt	11-23
R139.	820 ohm	10-75
R140.	100 ohm	10-7
R141.	15K	10-81
R142.	Deleted	
R143.	470K	10-11
R144.	Deleted	
R145.	47 ohm	10-29
R146.	10 ohm 1 watt	11-22
R147.	47 ohm	10-29
R148.	50 ohm thermistor (special)	210-3
RFC1.	Plate Chike	30-13
RFC2.	750uh	30-3
RFC3.	750uh	30-3
RFC4.	2.5uh	30-9
RFC5.	750uh	30-3
RFC6.	10 meter trap choke	30-24
RFC7.	15 meter trap choke	30-23
RFC8.	2.2uh	30-22
RFC9.	39uh	30-21
RFC10.	750uh	30-3
RFC11.	39uh	30-21
RFC12.	.56uh	30-23
RFC13.	20 meter trap choke	30-37
D1.	1N34	112-2
D2.	1N4738	112-9
D3.	1N501	112-3
D4.	1N4738	112-9
D5.	1N501	112-3

D6.	1N34	112-2
D7.	1N462	112-5
D8.	1N462	112-5
D9.	2N2926A	111-6
D10.	2N2926A	111-6
D11.	1N501	112-3
Q1.	2N4354	111-16
Q2.	2N29260	111-6
Q3.	2N3563	111-15
Q4.	2N2926Y	111-6
Q5.	2N3638	111-10
Q6.	2N4107 Matched Pair	111-18
Q7.	2N4107	
Q8.	2N2926G	111-6
Q9.	2N29260	111-6
Q10.	2N29260	111-6
Q11.	2N2646	111-7
Q12.	2N3563	111-15
Q13.	2N2926Y	111-6
Q14.	2N3638	111-10
Q15.	2N3563	111-15
Q16.	2N2926G	111-6
J1.	Remote VFO Socket	61-7
J2.	Xtal Cal Socket	61-7
J3.	Key Jack	102-1
J4.	Mic	
J5.	Ext Con	100-5 3 together
J6.	Alc 8 K1-5	
J7.	Remote VFO	100-4
J8.	Microphone Jack	103-3
J9.	Xov Socket	61-17
J10.	Spkr	100-4
J11.	Ant	101-1
J12.	PTT	100-4
J13.	Filt in	
J14.	12 VDC	100-5 3 together
J15.	Filt out	
X1.	21.5 MHZ	117-6
X2.	35.5 MHZ	117-7
X3.	42.5 MHZ	117-8
X4.	43.0 MHZ	117-9
X5.	LF	117-21A
X6.	HF	117-21B
X7.	28.5 MHZ	117-32

S1B-J.	Main Band sw.	53-40
S1K-N.	Conv. Band sw.	53-38
S2.	A & B Side band sw.	53-13
S3.	A-D Function sw.	53-28
S4.	Part of R122 & R127	See R122
Vox Jumper Strip		200-4
P2.	Octal jumper plug	109-1
P1.	Power plug	104-5
M1.	Panel meter	115-13
Knob	VFO 2½"	130-14-17
Knob	concertric bottom	130-14-19
Knob	concertric top	130-14-20
Knob	regular	130-14-18
Knob	pointer	130-14-21
VFO	Escusheon	134-8
Meter	eschuseon	134-9

GALAXY GT 550
SCHEMATIC

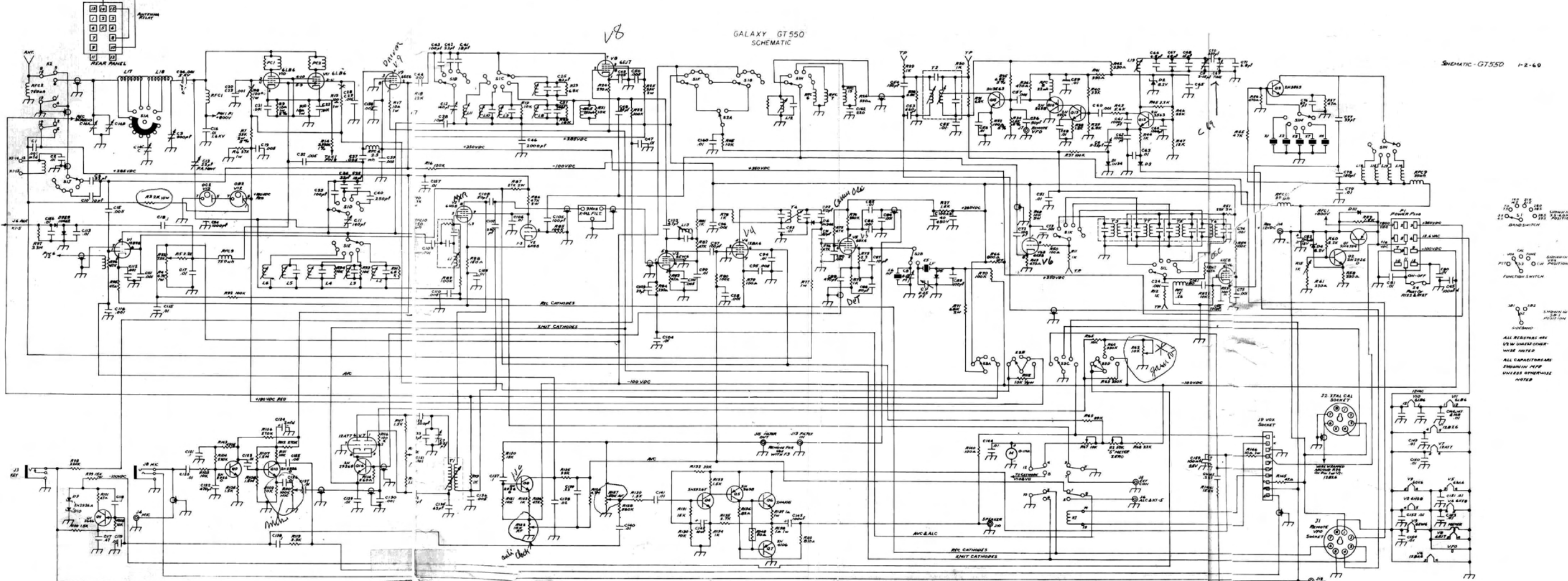

- | | |
|-----|-----|
| 22 | 218 |
| 110 | 0 |
| 22 | 0 |
| 22 | 0 |

22	218
110	0
22	0
22	0

22	218
110	0
22	0
22	0
- | | |
|-----|-----|
| 22 | 218 |
| 110 | 0 |
| 22 | 0 |
| 22 | 0 |
- | | |
|-----|-----|
| 22 | 218 |
| 110 | 0 |
| 22 | 0 |
| 22 | 0 |
- | | |
|-----|-----|
| 22 | 218 |
| 110 | 0 |
| 22 | 0 |
| 22 | 0 |

ALL RESISTORS ARE
 1/2 W UNLESS OTHERWISE
 NOTED
 ALL CAPACITORS ARE
 50V UNLESS OTHERWISE
 NOTED